

A New Control Algorithm for Active Suspension Systems Featuring Hysteresis

Domenico Guida

Full Professor
University of Salerno
Department of Industrial Engineering (DIIN)
Italy

Carmine M. Pappalardo

Research Fellow
University of Salerno
Department of Industrial Engineering (DIIN)
Italy

In this paper the vibration suppression problem relative to the vertical motion of road vehicles is investigated. In particular, the goal of the research is to design control laws for active suspension systems of road vehicles in order to reduce unwanted vibrations induced by a rough road profile. The road vehicle has been represented with a quarter-car model whereas the suspension system has been schematized using the Bouc-Wen hysteresis model. In addition, a control actuator has been collocated between the sprung mass and the unsprung mass. Since the problem under study is nonlinear, the time history of the control action has been obtained numerically using the iterative adjoint-based control optimization method. Simulations show that the designed control action significantly mitigates the vibrations induced by the road profile.

Keywords: Nonlinear Dynamics, Quarter-Car Model, Bouc-Wen Hysteresis Model, Vibrations Suppression, Iterative Adjoint-Based Control Optimization.

1. INTRODUCTION

Suspension systems of road vehicles are needed to guarantee a good ride quality for the vehicle occupants and at the same time to obtain a good vehicle stability [1-2]. Typically, suspension systems are realised using passive components. The design of a passive suspension system is performed making a trade-off between these two conflicting goals, namely the demand of a good ride quality and the need of a good vehicle stability [3-4]. The main drawback of a passive suspension system is that the suspension force can be only a function of the relative displacement and of the relative velocity between the sprung mass and the unsprung mass. On the other hand, active suspension systems can improve the performance of road vehicle suspensions circumventing these design constraints [5-6].

In this paper a new method to control nonlinear underactuated mechanical systems has been developed. This method originated from optimal control theory [7-10] and it is based on the iterative adjoint-based control optimization algorithm [11-17]. The proposed method has been applied to design control laws for active suspensions system of road vehicles in order to mitigate road-induced vibrations. The hysteresis phenomenon of the suspension system has been represented using Bouc-Wen hysteresis model.

2. SYSTEM MODEL

2.1 System Description

The system under study is a quarter-car model characterised by an hysteretic suspension system and

equipped with an active controller showed in figure 1.

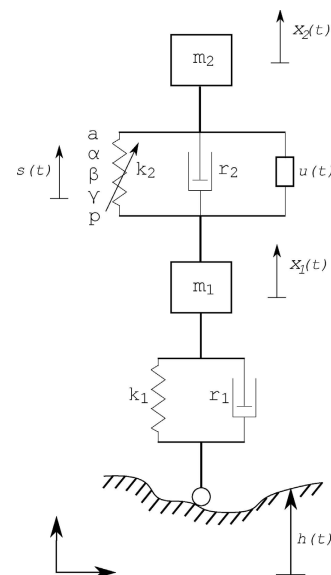

Figure 1. Quarter-Car Model with Hysteretic Suspension System and Active Controller

The displacement of the unsprung mass is denoted with x_1 whereas the displacement of the sprung mass is denoted with x_2 . The unsprung mass is denoted with m_1 whereas the sprung mass is denoted with m_2 . The tyre stiffness is denoted with k_1 whereas the tyre damping is denoted with r_1 . The suspension system is realised by a nonlinear device interposed between the sprung mass and the unsprung mass. The suspension stiffness is denoted with k_2 whereas the suspension damping is denoted with r_2 . The nonlinear suspension device provides a nonlinear elastic force field and a linear dissipative force field. The nonlinear suspension device is an hysteretic suspension system which is described using the Bouc-Wen model of hysteresis [18-20]. According to the Bouc-Wen model, the restoring force $\varphi(\Delta_2(t), s(t), t)$ can be expressed as:

Received: September 2013, Accepted: November 2013

Correspondence to: Carmine Maria Pappalardo
DIIN - Department of Industrial Engineering -
University of Salerno,
84084 Fisciano (Salerno) - Italy
E-mail: cpappalardo@unisa.it

© Faculty of Mechanical Engineering, Belgrade. All rights reserved

$$\varphi(\Delta_2(t), s(t), t) = -\alpha k_2 \Delta_2(t) + (1-\alpha)k_2 s(t) \quad (0.1)$$

where $\Delta_2(t)$ is the relative displacement between the sprung mass and the unsprung mass, $s(t)$ is a function of time which denotes the hysteretic displacement and α denotes the ratio of the post-yield to pre-yield stiffness. The time evolution of the hysteretic displacement is described by the following differential equation:

$$\dot{s}(t) = \psi(\Delta_2(t), s(t), t) \quad (0.2)$$

The nonlinear function $\psi(\Delta_2(t), s(t), t)$ is defined as:

$$\begin{aligned} \psi(\Delta_2(t), s(t), t) = & \\ = (a - (\beta \text{sign}(s(t)\dot{\Delta}_2(t)) + \gamma) \cdot & \\ \cdot (s(t) \text{sign}(s(t)))^p) \dot{\Delta}_2(t) & \end{aligned} \quad (0.3)$$

where a , β , γ , and p are dimensionless parameters which regulate the shape of the hysteresis loops. Linearising the system around its stable equilibrium configuration, the resulting system natural frequencies are denoted respectively with $f_{n,1}$ and $f_{n,2}$ whereas the resulting system damping ratios are denoted respectively with ξ_1 and ξ_2 . Considering a worst-case scenario, the quarter-car system is excited by a road profile $h(t)$ which is assumed as a superposition of two harmonic displacements whose harmonic content is close to the linearised system natural frequencies. Indeed:

$$h(t) = H_1 \sin(2\pi f_1 t) + H_2 \sin(2\pi f_2 t) \quad (0.4)$$

where H_1 and H_2 denote the amplitudes of the road roughness whereas f_1 and f_2 denote the frequencies of the road roughness. A detailed list of all system data is reported in table 1.

2.2 Equations of Motion

The configuration of the system can be defined using a set of $n=2$ degrees of freedom. Indeed, system generalized coordinates can be grouped in a vector $q(t)$ as:

$$q(t) = \begin{bmatrix} x_1(t) \\ x_2(t) \end{bmatrix} \quad (0.5)$$

where $x_1(t)$ denotes the displacement of the unsprung mass and $x_2(t)$ denotes the displacement of the sprung mass. System equations of motion can be derived using Lagrangian Dynamics [21-22] to yield:

$$\begin{aligned} M(q(t), t) \ddot{q}(t) = & \\ = Q(q(t), \dot{q}(t), s(t), h(t), \dot{h}(t), t) & \end{aligned} \quad (0.6)$$

where $M(q(t), t)$ is system mass matrix and $Q(q(t), \dot{q}(t), s(t), h(t), \dot{h}(t), t)$ is the vector of generalised forces acting on the system. For the problem on hand, the system mass matrix and the vector of generalised forces are defined as follows:

$$M(q(t), t) = \begin{bmatrix} m_1 & 0 \\ 0 & m_2 \end{bmatrix} \quad (0.7)$$

$$\begin{aligned} Q(q(t), \dot{q}(t), s(t), h(t), \dot{h}(t), t) = & \\ = \begin{bmatrix} -k_1(x_1(t) - h(t)) - \varphi(\Delta_2(t), s(t), t) + \\ -r_1(\dot{x}_1(t) - \dot{h}(t)) - r_2(\dot{x}_1(t) - \dot{x}_2(t)) \\ \varphi(\Delta_2(t), s(t), t) + r_2(\dot{x}_1(t) - \dot{x}_2(t)) \end{bmatrix} & \end{aligned} \quad (0.8)$$

If a control action $Q_c(u(t), t)$ is introduced on the system, the matrix form of system equations of motion becomes:

$$\begin{aligned} M(q(t), t) \ddot{q}(t) = & \\ = Q(q(t), \dot{q}(t), s(t), h(t), \dot{h}(t), t) + & \\ + Q_c(u(t), t) & \end{aligned} \quad (0.9)$$

For the system under study, the control input $u(t)$ is a force acting between the sprung and the unsprung mass. Therefore, the control action can be written as:

$$Q_c(u(t), t) = B_2(t)u(t) \quad (0.10)$$

where $B_2(t)$ is a Boolean matrix defined as follows:

$$B_2(t) = \begin{bmatrix} -1 \\ 1 \end{bmatrix} \quad (0.11)$$

Since the rank of the Boolean matrix $B_2(t)$ is $b_2 = 1$ and it is lesser than the number of system degrees of freedom $n_2 = 2$, the quarter-car model is an underactuated mechanical system.

3. RESULTS AND DISCUSSION

3.1 Control Development

A regulation controller has been designed by using the iterative adjoint-based control optimization method [23-33]. The goal of the regulation controller is to reduce the vibration amplitudes of the sprung and unsprung masses induced by the road excitation. The synthesis of the regulation controller provides a feedforward control action and the corresponding evolution of the system state.

3.2 Regulation Controller Design

The regulation controller is an open-loop controller which has been designed using the iterative adjoint-based control optimization method. The control scheme which describes how the regulation controller acts on the system is represented in figure 2.

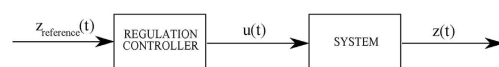

Figure 2. Control Scheme for Regulation Controller

The weight matrices which characterise the cost function have been defined as follows:

$$Q_T(T) = \text{diag}(10^4, 10^4, 10^4, 10^4, 10^4) \quad (0.12)$$

$$Q_z(t) = \text{diag}(10^4, 10^4, 10^4, 10^4, 10^4) \quad (0.13)$$

$$Q_u(t) = 10^{-4} \quad (0.14)$$

where $Q_T(T)$ denotes the final state cost matrix, $Q_z(t)$ denotes the state cost matrix and $Q_u(t)$ denotes the input cost matrix. Figure 3 shows the iterative convergence towards the minimum of the cost function.

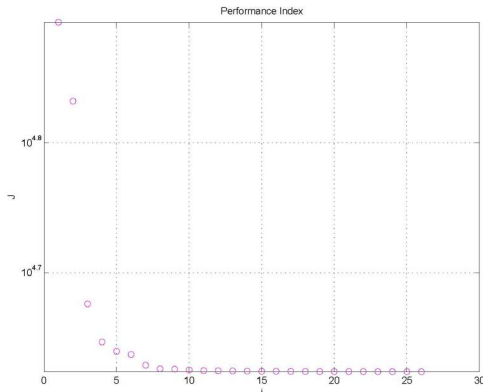

Figure 3. Cost Function - J

Figure 4 shows the time history of the resulting regulation controller.

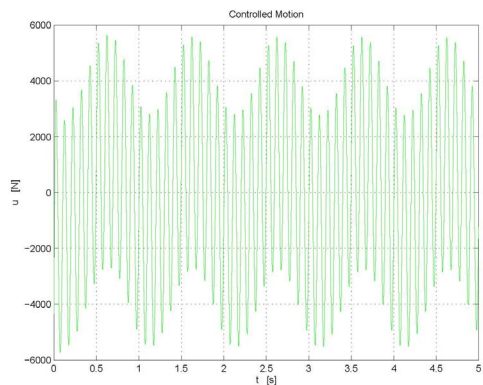

Figure 4. Regulation Controller - $u(t)$

Figure 5 represents the displacement of the unsprung mass when the system is uncontrolled.

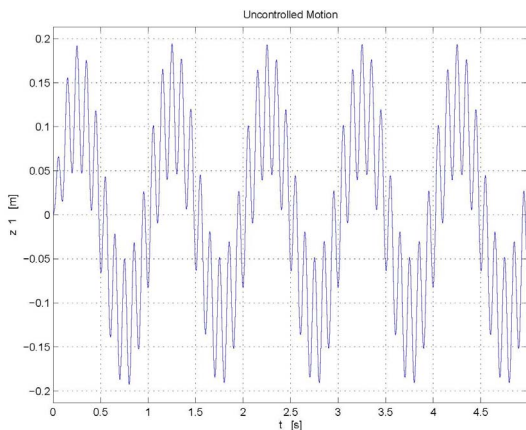

Figure 5. Uncontrolled Motion - $x_1(t)$

Figure 6 represents the displacement of the unsprung mass when the regulation controller acts on the system.

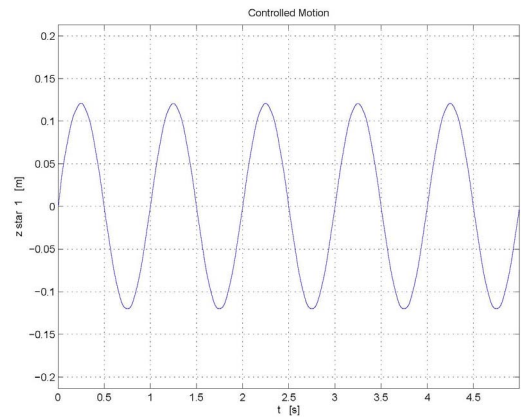

Figure 6. Controlled Motion - $x_1(t)$

Figure 7 represents the displacement of the sprung mass when the system is uncontrolled.

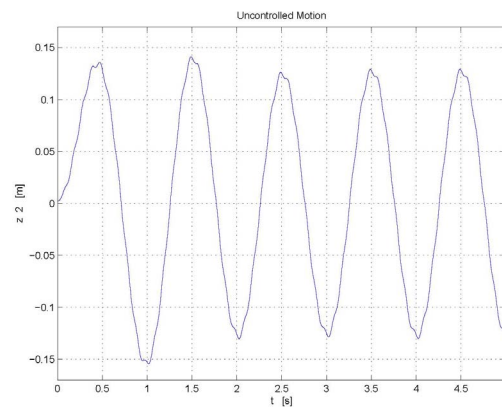

Figure 7. Uncontrolled Motion - $x_2(t)$

Figure 8 represents the displacement of the sprung mass when the regulation controller acts on the system.

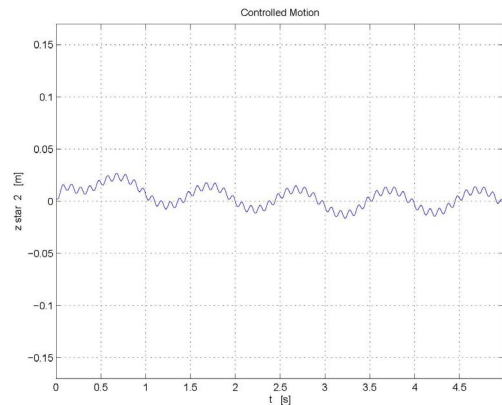

Figure 8. Controlled Motion - $x_2(t)$

These figures show that the effect of the action of the regulation controller is a considerable amplitude reduction of both the unsprung mass displacement and of the sprung mass displacement. The amplitude reductions of both displacements ε_{x_1} and ε_{x_2} can be quantified comparing the maximum amplitudes of system motion with and without the controller as follows:

$$\varepsilon_{x_1} = \frac{X_{1,u} - X_{1,c}}{X_{1,u}} = 37.62\% \quad (0.15)$$

$$\varepsilon_{x_2} = \frac{X_{2,u} - X_{2,c}}{X_{2,u}} = 88.46 \% \quad (0.16)$$

where $X_{1,u}$ and $X_{2,u}$ denote the maximum amplitudes of system steady-state displacements when there is no control action whereas $X_{1,c}$ and $X_{2,c}$ denote the maximum amplitudes of system steady-state motion when the regulation controller acts on the system.

4. CONCLUSIONS

Authors' research is focused on the development of new and effective methods to design control strategies for nonlinear mechanical systems [34-44]. In this paper authors propose a general and effective method to control nonlinear underactuated mechanical systems. The proposed method is based on the iterative adjoint-based control optimization algorithm. This method has been utilized to design control laws for active suspension systems of road vehicles which present the hysteresis phenomenon. The system analyzed has been idealized using a quarter-car model whereas the suspension systems has been schematized using the Bouc-Wen hysteresis model. The quarter-car system has been excited by a rough road profile which has been assumed as a superposition of two harmonic functions whose harmonic content is close to the linearized system natural frequencies. An active control system has been collocated between the sprung mass and the unsprung mass in order to reduce the amplitude of the vibrations caused by the roughness of the road profile. The problem on hand has been solved designing a regulation controller using the iterative adjoint-based control optimization method and the resulting regulation controller is an open-loop controller. The synthesis of the regulation controller provides a feedforward control action which drastically reduces the amplitude of the displacements relative to the sprung mass and to the unsprung mass. Authors believe that the proposed method represents a viable solution to control nonlinear underactuated mechanical systems.

REFERENCES

[1] Blundell, M. and Harty, D.: *The Multibody Systems Approach to Vehicle Dynamics*, Elsevier, 2004.
 [2] Pacejka, H.B.: *Tire and Vehicle Dynamics*, Butterworth-Heinemann, 2012.
 [3] Ewins, D.J., Rao, S.S. and Braun, S.G., *Encyclopedia of Vibration*, Academic Press.
 [4] Rajamani, R.: *Vehicle Dynamics and Control*, Springer-Verlag, 2005.
 [5] Preumont, A.: *Vibration Control of Active Structures*, Kluwer Academic Pub, 2003.
 [6] Gawronski, W.K.: *Advanced Structural Dynamics and Active Control of Structures*, Springer-Verlag, 2004.
 [7] Bryson, A.E. and Ho, Y.C.: *Applied Optimal Control: Optimization, Estimation and Control*, Taylor and Francis.

[8] Lewis, F.L., Vrabie, D.L. and Syrmos V.L.: *Optimal Control*, John Wiley and Sons, 2012.
 [9] Kirk, D.E.: *Optimal Control Theory: An Introduction*, Dover, 2004.
 [10] Bertsekas, D.P.: *Dynamic Programming and Optimal Control*, Athena Scientific, 2005.
 [11] Luchini, P. and Bottaro, A.: Adjoint equations in stability analysis, *Annual Review of Fluid Mechanics*, Vol. 46, pp.1-30, 2013.
 [12] Luchini, P. and Bottaro, A.: An introduction to adjoint problems, *Annual Review of Fluid Mechanics*, Vol. 46, Supplemental Appendix A, 2014.
 [13] Giannetti, F., Camarri, S. and Luchini, P.: Structural sensitivity of the secondary instability in the wake of a circular cylinder, *Journal of Fluid Mechanics*, Vol. 651, pp.319-337, 2010.
 [14] Luchini, P., Giannetti, F. and Pralits, J.O.: Optimal Control of a Thin-Airfoil Wake using a Riccati-Less Approach, in: *Programme and Proceedings of 8th Euromech Fluid Mechanics Conference*, Bad Reichenhall Germany, September 13-16, 2010, TUM and European Mechanics Society, Vol.2, Pag.EUCASS MS-2-EUCASS MS-2, 2010.
 [15] Bewley, T.R.: *Numerical renaissance: simulation, optimization and control*, Renaissance Press, To be published.
 [16] Bewley, T.R.: A Linear systems approach to flow control, *Annual Review of Fluid Mechanics*, Vol. 39, pp. 383-417, 2007.
 [17] Bewley, T.R.: Flow control: new challenges for a new renaissance, *Progress in Aerospace Sciences*, Vol. 37, pp. 21-58, 2001.
 [18] Ikhouane, F. and Rodellar, J.: *Systems with Hysteresis: Analysis, Identification and Control Using the Bouc-Wen Model*, Wiley-Interscience, 2007.
 [19] Genta, G.: *Vibration Dynamics and Control*, Springer, 2009.
 [20] Inman, D.J.: *Vibration with Control*, John Wiley and Sons, 2006.
 [21] Shabana, A.A.: *Computational Dynamics*, Cambridge, 2010.
 [22] Shabana, A.A.: *Dynamics of Multibody Systems*, Cambridge, 2010.
 [23] Guida, D., Nilvetti, F. and Pappalardo, C.M.: Optimal Control Design by Adjoint-Based Optimization for Active Mass Damper with Dry Friction, in: *Programme and Proceedings of COMPDYN 2013 4th International Conference on Computational Methods in Structural Dynamics and Earthquake Engineering*, 12-14 June, Kos Island, Greece, 2013.
 [24] Guida, D., Nilvetti, F. and Pappalardo, C.M.: Adjoint-based Optimal Control Design for a Cart Pendulum System with Dry Friction, in: *Programme and Proceedings of ECCOMAS Thematic Conference on Multibody Dynamics 2013*, July, 1-4, Zagreb, Croatia, 2013.

- [25] Guida, D. and Pappalardo, C.M.: Iterative Adjoint-Based Control Optimization for Active Suspension of Quarter-Car Model, in: *Programme and Proceedings of International Conference on Vibration Problems (ICOVP-2013)*, 9-12 September, Lisbon, Portugal, 2013.
- [26] Nilveti, F. and De Simone, M.C.: Test-Rig for Identification and Control Applications, in: *Programme and Proceedings of International Conference on Vibration Problems (ICOVP-2013)*, 9-12 September, Lisbon, Portugal, 2013.
- [27] Guida, D. and Pappalardo, C.M.: Optimal control design of an active mass damper with dry friction: International Journal of Mechanical Engineering and Industrial Design, Volume 2, No. 4, pp. 27-39, 2013.
- [28] Guida, D. and Pappalardo, C.M.: Swing-up and stabilization of an inverted pendulum with dry friction, International Journal of Mechanical Engineering and Industrial Design Volume 2, No. 5, pp. 40-56, 2013.
- [29] Guida, D., Pappalardo, C.M.: A new method for control law design of a quarter-car suspension system, International Journal of Mechanical Engineering and Industrial Design, Vol. 1, No. 5, pp. 37-58, 2013.
- [30] Nilveti F. and De Simone, M.C.: Identification and control of an unmanned ground vehicle, International Journal of Mechanical Engineering and Industrial Design, Vol. 1, No.3, pp.16-21, 2013.
- [31] Pappalardo, C.M.: *Dynamics, Identification and Control of Multibody Systems*, Ph.D. Thesis, Department of Industrial Engineering, University of Salerno, Italy, 2012.
- [32] Guida, D. and C.M., Pappalardo: A new control algorithm for nonlinear underactuated mechanical systems, International Journal of Mechanical Engineering and Industrial Design, Vol. 1, No. 4, , pp. 61-82, 2012.
- [33] Pappalardo, C.M.: Combination of extended udwadia-kalaba control algorithm with extended kalman filter estimation method, International Journal of Mechanical Engineering and Industrial, Vol. 1, No. 1, pp. 1-18, 2012.
- [34] Guida, D., Nilveti, F. and Pappalardo C.M.: Parameter identification of a two degrees of freedom mechanical system, WSEAS Transactions on International Journal of Mechanics, Vol. 3, No. 2, pp. 23-30 2009.
- [35] Guida, D. and Pappalardo C.M.: Sommerfeld and mass parameter identification of lubricated journal bearing, WSEAS Transactions on Applied and Theoretical Mechanics, Vol. 4, No. 4, pp. 205-214, 2009.
- [36] Guida, D., Nilveti, F. and Pappalardo, C.M.: Dry friction influence on cart pendulum dynamics, International Journal of Mechanics, Vol. 3, No. 2, pp. 31-38, 2009.
- [37] Guida, D., Nilveti, F. and Pappalardo, C.M.: Dry friction of bearings on dynamics and control of an inverted pendulum, Journal of Achievements in Materials and Manufacturing Engineering, Vol. 38, No. 1, pp. 80-94, 2010.
- [38] Guida, D., Nilveti, F. and Pappalardo, C.M.: Parameter identification of a full-car model for active suspension design, Journal of Achievements in Materials and Manufacturing Engineering, Vol. 40, No. 2, pp. 138-148, 2010.
- [39] D'Ambrosio, S., Guida, D., Pappalardo, C.M. and Quartieri J.: Nonlinear identification method of multibody system parameters, in: *Proceedings of IPMM-2007 The 6th International Conference*, Vol. 1, pp. 27-31, 2007.
- [40] Nilveti, F., Pappalardo, C.M. and Guida, D., Mass, stiffness and damping identification of a two-story building model, International Journal of Mechanical Engineering and Industrial Design Vol. 1, No. 2, pp. 19-35, 2012.
- [41] Guida, D., Nilveti, F. and Pappalardo, C.M.: modelling, identification and control of a three-story building system, International Journal of Mechanical Engineering and Industrial Design, Vol. 1, No. 3, pp. 36-60, 2012.
- [42] Nilveti, F., Pappalardo, C.M. and Guida, D.: Experimental Investigation of a virtual passive absorber for structural vibration control, International Journal of Mechanical Engineering and Industrial Design, Vol. 1, No. 5, pp. 83-90, 2012.
- [43] Guida, D., Nilveti, F. and Pappalardo, C.M.: Experimental investigation of an active structural control device, International Journal of Mechanical Engineering and Industrial Design, Vol. 1, No. 6, pp. 91-96, 2012.
- [44] Guida, D. and Pappalardo, C.M.: Control Design of an active suspension system for a quarter-car model with hysteresis, Advances in Vibration Engineering (AVE), To be published.

**НОВИ АЛГОРИТАМ УПРАВЉАЊА
АКТИВНИМ СИСТЕМИМА ВЕШАЊА СА
КАРАКТЕРИСТИКАМА ХИСТЕРЕЗЕ**

Domenico Guida, Carmine M. Pappalardo

У овом раду се истражује проблем пригушивања вибрација у односу на вертикално кретање друмских возила. Истакнуто је да је циљ истраживања пројектовање закона управљања за активне системе вешања да би се редуковале непожељне вибрације које изазива нераван профил друма. Друмско возило је представљено моделом четвртине возила, док је шема система вешања изражена коришћењем Бок-Вановог модела хистерезе. Поред тога, актуатор управљачког система је постављен између оптерећене и неоптерећене масе. Пошто је проблем истраживања нелинеаран, управљање по времену је

добијено нумерички применом итеративне методе оптимизације спрегнутог управљања. Симулације

показују да пројектовано управљање знатно ублажава вибрације изазване профилем друма

Table 1. System Data.

| DESCRIPTION | SYMBOLS | DATA [UNITS] |
|--|----------------|--------------------------------|
| Unsprung Mass | m_1 | 40 [kg] |
| Sprung Mass | m_2 | 300 [kg] |
| Tyre Stiffness | k_1 | 140000 [kg · s ⁻²] |
| Suspension Stiffness | k_2 | 12000 [kg · s ⁻²] |
| Tyre Damping | r_1 | 80 [kg · s ⁻¹] |
| Suspension Damping | r_2 | 800 [kg · s ⁻¹] |
| Suspension Post-yield to Pre-yield Stiffness Ratio | α | 0.5 [∖] |
| Bouc-Wen Model Hysteresis Parameter | a | 1 [∖] |
| Bouc-Wen Model Hysteresis Parameter | β | 500 [∖] |
| Bouc-Wen Model Hysteresis Parameter | γ | 100 [∖] |
| Bouc-Wen Model Hysteresis Parameter | p | 2.5 [∖] |
| First Mode Natural Frequency | $f_{n,1}$ | 0.9716 [s ⁻¹] |
| Second Mode Natural Frequency | $f_{n,2}$ | 9.7552 [s ⁻¹] |
| First Mode Damping Ratio | ξ_1 | 0.1870 [∖] |
| Second Mode Damping Ratio | ξ_2 | 0.1825 [∖] |
| Ground Displacement Amplitude 1 | H_1 | 0.12 [m] |
| Ground Displacement Amplitude 2 | H_2 | 0.03 [m] |
| Ground Displacement Frequency 1 | f_1 | 1 [s ⁻¹] |
| Ground Displacement Frequency 2 | f_2 | 10 [s ⁻¹] |
| Initial Displacement of Unsprung Mass | $x_{1,0}$ | 0.001 [m] |
| Initial Displacement of Sprung Mass | $x_{2,0}$ | 0.002 [m] |
| Initial Velocity of Unsprung Mass | $v_{1,0}$ | 0.03 [m · s ⁻¹] |
| Initial Velocity of Sprung Mass | $v_{2,0}$ | 0.04 [m · s ⁻¹] |
| Initial Hysteretic Displacement | s_0 | 0.001 [m] |
| Time Span | T | 5 [s] |
| Time Step | Δt | 0.001 [s] |