

## Proračun čvrstoće točkova železničkih vozila

Vladimir Sindelić<sup>1\*</sup>, Milan Bižić<sup>1</sup>, Dragan Petrović<sup>1</sup>

<sup>1</sup> Fakultet za mašinstvo i građevinarstvo u Kraljevu, Univerzitet u Kragujevcu, Kraljevo (Srbija)

*Ovaj rad prikazuje metodologiju proračuna čvrstoće točkova železničkih vozila prema aktuelnim međunarodnim standardima. Metodologija je demonstrirana na primeru monoblok točka standardnog osovinskog sklopa teretnog vagona za osovinsko opterećenje od 200 kN. Analiza naponsko-deformacionih stanja i statičkog i dinamičkog stepena sigurnosti točka izvršena je primenom metode konačnih elemenata u softverskom paketu ANSYS. Za određivanje veličine površina kontakta na mestima gde su zadavana opterećenja primenjena je Hercova teorija kontakta između dva elastična tela. Dobijeni rezultati su pokazali da analizirani točak ima potrebne stepene sigurnosti i zadovoljava sve kriterijume čvrstoće definisane standardima.*

**Keywords: Proračun čvrstoće, Železnička vozila, Monoblok točak, Hercova teorija kontakta, Metoda konačnih elemenata**

### 1. UVOD

Točak železničkog vozila zajedno sa osovinom je jedan od najvažnijih delova preko koga se ostvaruje kretanje železničkog vozila po koloseku. Takođe točkovi trpe celokupno opterećenje od konstrukcije (sanduk, donje postolje, obrtno postolje, ...) železničkog vozila. Tokom svoje eksploatacije u različitim radnim i vremenskim uslovima točkovi su izloženi dinamičkim opterećenjima koja često imaju karakter izrazito udarnih opterećenja visokog intenziteta. Zbog toga se pred železničke točkove postavljaju izuzetno visoki zahtevi u pogledu kvaliteta. Postoje dve osnovne varijante izrade točka i to: točak sa obručom i monoblok (jednodelni) točak. Točak sa obručom se sastoji od tela točka, obruča i sigurnosnog prstena. Monoblok točak se izrađuje iz jednog komada čelika. Kod vozila sa normalnim kolosekom čija je konstrukciona brzina iznad 160 km/h Međunarodna železnička unija (UIC) dopušta jedino monoblok točkove. Razlog tome je opasnost od labavljenja obruča usled dejstva centrifugalne sile. Izrada monoblok točka je znatno jednostavnija od točka sa obručom, jer se izbegava obrada naležućih površina i montaža obruča. Takođe je i masa monoblok točka manja, pošto se sastoji iz jednog dela i njegov obod može biti tanji od točka sa obručom [1, 2].

S obzirom da su točkovi dinamički i statički najopterećeniji delovi železničkih vozila i imaju veoma odgovornu funkciju, njihovi nedostaci mogu ugroziti bezbednost kretanja. Zbog toga je neophodno da se izvrši pravilan proračun čvrstoće točka.

Danas eksperimentalna provera točkova železničkih vozila ima alternativu u proračunima i simulacijama u sofisticiranim softverskim alatima. Ovi alati pružaju inženjerima niz procena još u početnim fazama razvoja točka železničkog vozila. Ovim postupkom se postiže efikasan način da se smanje troškovi izrade prototipa i da se dobije ekonomično rešenje, kao i da se skрати vreme do plasiranja proizvoda – točka na tržište. Takođe obezbeđuje se i dodatna prednost u dizajnu proizvoda koja se ogleda u mogućnosti analize strukturalnog ponašanja sa ciljem poboljšanja performansi proizvoda – točka [3].

Za ove svrhe koristi se uglavnom metoda konačnih elemenata (MKE), kao jedna od metoda softverske analize

mašinskih konstrukcija, koja omogućava analizu proizvoda još u ranim fazama razvoja i proizvodnje [4-5]. Ova metoda se već dugi niz godina uspešno koristi u analizi čvrstoće elemenata železničkih vozila.

Primenom metode konačnih elemenata razvijaju se trodimenzionalni modeli koji omogućavaju izračunavanje mehaničkih opterećenja u bilo kojoj tački točka, a dobijeni rezultati pokazuju dobro slaganje sa realnim vrednostima dobijenim eksperimentalnim ispitivanjima [6]. Na sličan način, moguće je modelirati i analizirati raspodelu temperature na točkovima različitih radijusa, temperature točkova za različite vrednosti brzine kretanja železničkog vozila, kao i raspodelu napona za različita opterećenja točka [7]. Takođe, metoda konačnih elemenata omogućava analizu zaostalih napona u točkovima železničkih vozila koji su uzrokovani naponima usled procesa termičke obrade točka [8]. U nekim istraživanjima metoda konačnih elemenata korišćena je za predviđanje rasta zamora materijala na železničkim točkovima i uticaja zaostalih napona, a dobijeni rezultati pokazali su dobro slaganje sa postignutim terenskim merenjima [9]. Metoda konačnih elemenata se veoma uspešno pokazala i u simulacijama i proračunima opterećenja železničkih šina [10], kao i kontaktnih naprezanja i analize habanja profila točka i šine [11].

U ovom radu je, primenom metode konačnih elemenata, izvršen proračun čvrstoće standardnog monoblok točka osovinskog sklopa teretnog vagona za normalnu širinu koloseka i osovinsko opterećenje od 200 kN. Materijal analiziranog točka je ER7 (oznaka prema Evropskim propisima EN), odnosno R7 (oznaka prema UIC propisima).

Osnovni cilj rada je da se demonstrira primena metode konačnih elemenata u proračunu čvrstoće železničkih točkova, kao i da se prikaže savremena metodologija proračuna čvrstoće točkova železničkih vozila, koja u najvećem broju slučajeva omogućava izbegavanje veoma skupih i dugotrajnih eksperimentalnih ispitivanja.

## 2. METODOLOGIJA PRORAČUNA ČVRSTOĆE TOČKOVA

Procedura proračuna točka odvija se u dve faze. Prva faza obuhvata proračun pod definisanim uslovima, a druga faza obuhvata ispitivanje na zamor i sprovodi se samo u slučaju ukoliko prva faza ne da zadovoljavajuće rezultate. Proračunom se dobijaju naponi u raznim tačkama tela točka, koji se po određenoj proceduri porede sa dozvoljenim naponima. Ukoliko su proračunski naponi u granicama dozvoljenih, ne postoji opasnost od naprslina usled zamora i smatra se da je točak korektno dimenzionisan. Ukoliko su izračunati naponi van dozvoljenih granica, potrebno je izvršiti promene dimenzija i oblika na telu točka i ponoviti proračun dok se naponi ne svedu u dozvoljene granice. Algoritam kompletnog postupka proračuna točka dat je na slici 1 [2].

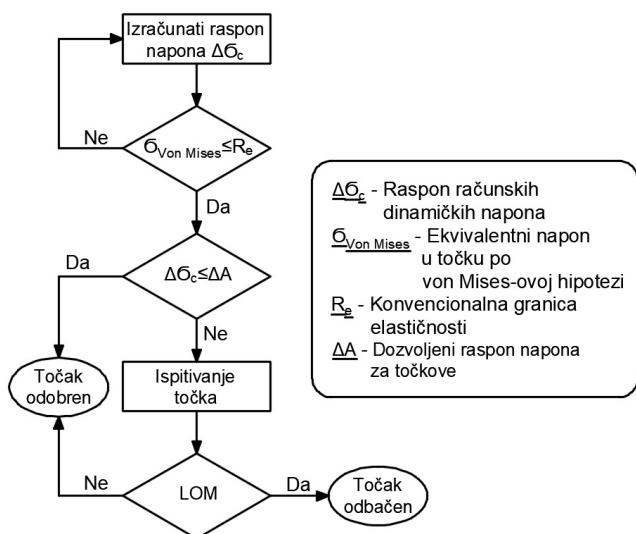

Slika 1. Algoritam provere čvrstoće točka

### 2.1. Merodavna opterećenja za proračun točka

Postupak određivanja merodavnih opterećenja baziran je na tri klasična slučaja: kada se kretanje točka ostvaruje na pravom koloseku; kada se železničko vozilo kreće kroz krivinu; i kada je obuhvaćeno kretanje odnosno prelazak preko skretnice i ukrasnice (standard EN 13979-1).

U prvom slučaju deluje samo vertikalna sila  $F_z$  od šine na nominalnom krugu kotrljanja na 70 mm od leđa točka (Slika 2), a vertikalna reakcija računa se prema sledećem obrascu:

$$F_z = 1,25 \cdot N \quad (1)$$

Kod drugog slučaja vertikalna sila  $F_z$  deluje u korenu venca vodećeg točka na rastojanju od 38 mm od leđa točka, a bočna sila  $F_{y1}$  deluje na vencu na 10 mm ispod nominalnog kruga kotrljanja (Slika 2), a obrasci su dati izrazima:

$$F_z = 1,25 \cdot N \quad (2)$$

$$F_{y1} = 0,7 \cdot N \quad (3)$$

Kod trećeg slučaja vodeći točak se nalazi u kanalu, pri čemu gubi oslonac za venac točka, a privremeno vođenje osovinskog sklopa preuzima suprotan točak koji se unutrašnjom stranom oslanja na šinu za vođenje. Bočna sila  $F_{y2}$  tada deluje na leđa točka na rastojanju od 10 mm ispod kruga kotrljanja, a vertikalna sila  $F_z$  deluje bliže

spoljašnjoj strani točka na 105 mm od leđa (Slika 2). Obrasci za ovaj slučaj su sledeći:

$$F_z = 1,25 \cdot N \quad (4)$$

$$F_{y2} = -0,42 \cdot N \quad (5)$$

U sva tri slučaja  $N$  predstavlja statičko opterećenje po točku.

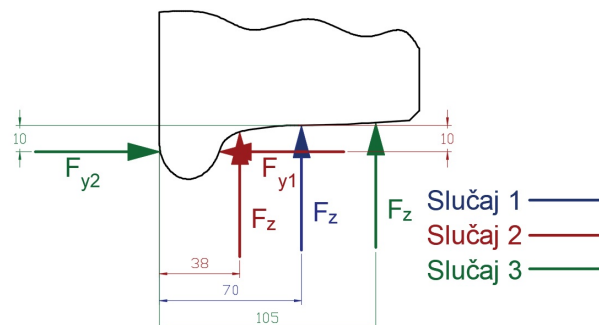

Slika 2. Propisani slučajevi opterećenja za proračun točka

## 3. ODREĐIVANJE VELIČINE KONTAKTNIH POVRŠINA

U kontaktnoj površini između točka i šine javljaju se veoma intenzivne sile akcije i reakcije koje imaju ključni uticaj na dinamičko ponašanje železničkih vozila i koloseka. Ove sile igraju ključnu ulogu u oslanjanju, vođenju, vuči i kočenju železničkih vozila tokom kretanja po koloseku [12].

Rešavanje normalnog kontaktnog problema točak-šina bazira se na Hercovoj statičkoj teoriji kontakta dva elastična tela. Hercova teorija može se primeniti pod sledećim pretpostavkama: pomeranje i deformacije su male veličine, zona kontakta je mala u poređenju sa dimenzijama točka i šine, odnosno mala je u odnosu na poluprečnik kotrljanja točka, oblast u blizini kontaktne površine je opisana konstantnom krivinom, površine kontakta su glatke, hrapavost se zanemaruje, postoje samo elastične deformacije i materijal točka i šine je homogen i izotropan [12]. Prema Hercu, kontaktna površina je oblika elipse sa poluosama  $a_e$  i  $b_e$  (slika 3).

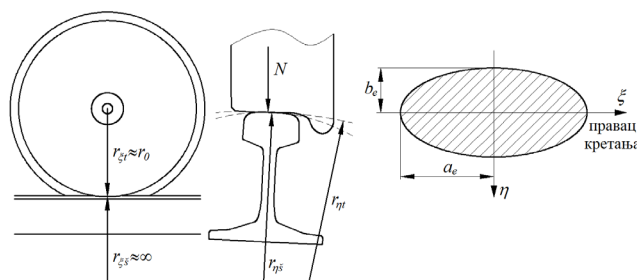

Slika 3. Kontaktna površina između točka i šine prema Hercovoj teoriji [12]

Polu ose elipse računaju se prema sledećem izrazu:

$$a_e = m \cdot \sqrt[3]{\frac{3}{2} \cdot \frac{N(1-\nu_p^2)}{E(A+B)}} \quad (6)$$

$$b_e = n \cdot \sqrt[3]{\frac{3}{2} \cdot \frac{N(1-\nu_p^2)}{E(A+B)}} \quad (7)$$

U izrazima (6) i (7)  $E$  je modul elastičnosti,  $\nu_p$  je Poasonov koeficijent,  $N$  je normalna sila,  $A$  i  $B$  su funkcije koje zavise od poluprečnika krivine točka u

podužnom pravcu  $r_{et}$ , poluprečnika krivine točka u poprečnom pravcu  $r_{\eta t}$ , poluprečnika krivine šine u podužnom pravcu  $r_{\varepsilon s}$  i poluprečnika krivine šine u poprečnom pravcu  $r_{\eta s}$ , a računaju se prema sledećim obrascima:

$$A = \frac{1}{2} \left( \frac{1}{r_{\eta s}} - \frac{1}{r_{\eta t}} \right) \quad (8)$$

$$B = \frac{1}{2} \left( \frac{1}{r_{\varepsilon s}} + \frac{1}{r_{et}} \right) \approx \frac{1}{2r_{et}} \approx \frac{1}{2r_0} \quad (9)$$

Veličine  $m$  i  $n$  predstavljaju konstante koje se određuju iz tablica, a na osnovu obrasca [12]:

$$\theta = \cos \left( \frac{A-B}{A+B} \right) \quad (10)$$

Površina kontakta točak-šina računa se:

$$A_e = \pi \cdot a_e \cdot b_e \quad (11)$$

### 3.1. Proračun veličine kontaktnih površina za zadavanje opterećenja

Za proračun veličine kontaktnih površina korišćena je šina oznake UIC 60 (Slika 4).

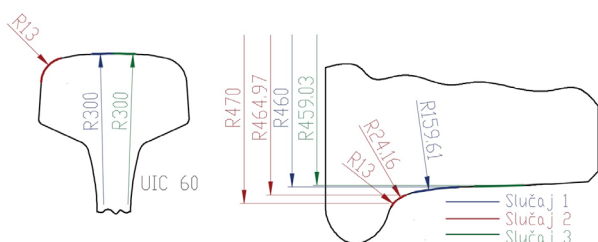

Slika 4. Vrednosti poluprečnika krivina šine i točka

Opterećenje točka je  $N = 200 \text{ kN}$ , modul elastičnosti točka i šine je  $E = 210 \text{ kN/mm}^2$  i Poasonov koeficijent iznosi  $\nu_p = 0,3$ .

Poluprečnici krivina za prvi slučaj iznose:  $r_{et} = 460 \text{ mm}$ ,  $r_{\eta t} = 159,61 \text{ mm}$ ,  $r_{\varepsilon s} = \infty$  i  $r_{\eta s} = 300 \text{ mm}$ .

U drugom slučaju kontakt točak-šina ostvaruje se na dve kontaktne površine točka različitih prečnika tako da u prvom regionu kontakta imamo:  $r_{et} = 464,97 \text{ mm}$ ,  $r_{\eta t} = -24,16 \text{ mm}$ ,  $r_{\varepsilon s} = \infty$  i  $r_{\eta s} = 13 \text{ mm}$ , a u drugom regionu:  $r_{et} = 470 \text{ mm}$ ,  $r_{\eta t} = -13 \text{ mm}$ ,  $r_{\varepsilon s} = \infty$  i  $r_{\eta s} = 13 \text{ mm}$ .

Kod trećeg slučaja kontakta, vrednosti poluprečnika iznose:  $r_{et} = 459,03 \text{ mm}$ ,  $r_{\eta t} = \infty \text{ mm}$ ,  $r_{\varepsilon s} = \infty$  i  $r_{\eta s} = 300 \text{ mm}$ .

Izračunate vrednosti kontaktnih površina za zadavanje opterećenja točka prikazane su u tabeli 1.

Tabela 1. Izračunate vrednosti kontaktnih površina

	I	II <sup>1</sup>	II <sup>2</sup>	III
$m$	1,17232	2,8932	0	1,1566
$n$	0,6481	0,4777	0	0,8732
$a_e$ (mm)	10,4163	11,8664	0	9,0031
$b_e$ (mm)	3,9177	1,9592	0	6,7970
$A_e$ (mm <sup>2</sup> )	128,2023	73,0360	0	192,2474

## 4. PRORAČUN TOČKA

Na osnovu tehničke dokumentacije fabrike Bonatrans, formirana je trodimenzionalna geometrija točka. Ova geometrija uvežena je u softverski paket ANSYS u kome je izvršena diskretizacija i formiranje proračunskog modela primenom metode konačnih elemenata. Način modeliranja kontaktnih površina iz prethodnog poglavlja u proračunskom modelu prikazan je na slici 5. U ovim površinama zadaju se opterećenja definisana u poglavlju 2. Proračunski model točka sadrži 224500 čvorova i 132995 konačnih elemenata (slika 6).

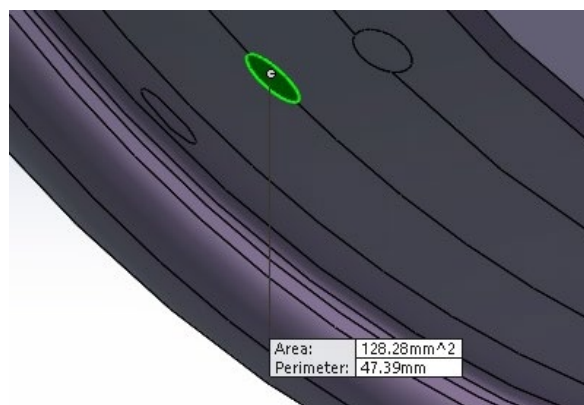

Slika 5. 3D Model točka sa kontaktnim površinama u kojima se zadaju opterećenja

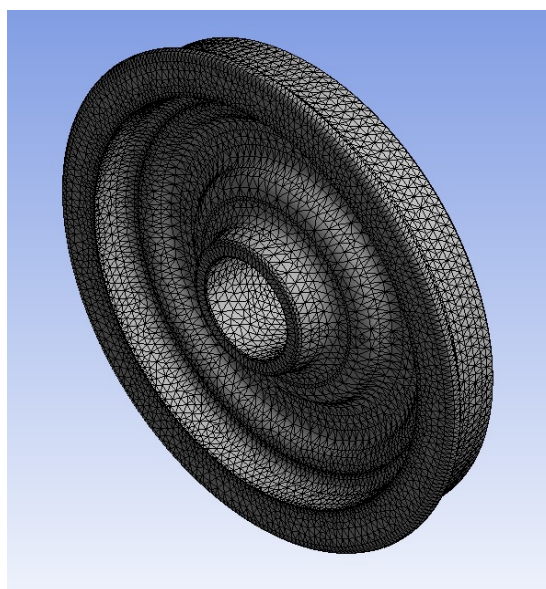

Slika 6. Diskretizovan model točka od 224500 čvorova i 132995 konačnih elemenata

Mesto spoja glavčine točka sa osovinom modelirano je kao nepokretni oslonac, odnosno pretpostavljeno je da nema pomeranja na mestu spoja sa osovinom (slika 7).

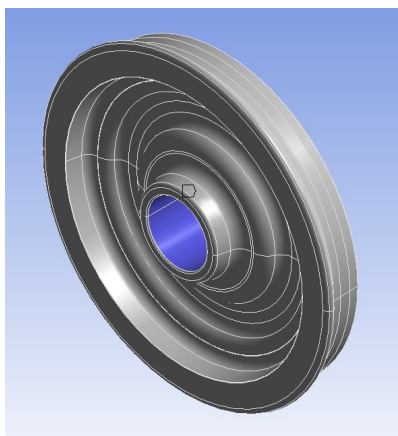

Slika 7. Nepokretni oslonac na mestu veze glavčine točka sa osovinom

Za zadati materijal točka ER7, u softverskom paketu ANSYS unete su sledeće vrednosti parametara materijala točka:  $R_{eh} = 520 \text{ N/mm}^2$  i  $R_m = 820 \text{ N/mm}^2$ , gde je  $R_{eh}$  granica tečenja a  $R_m$  zatezna čvrstoća.

U cilju dinamičkog proračuna, u programski paket ANSYS uneti su parametri materijala točka. Trajna dinamička izdržljivost za obrađeno telo točka odgovara broju od 10 miliona ciklusa promene napona i iznosi  $180 \text{ N/mm}^2$  [2].

Vrednosti sila izračunate prema poglavlju 2 za sva tri slučaja opterećenja iznose:

- Slučaj 1:  $F_z = 250 \text{ kN}$ ,
- Slučaj 2:  $F_z = 250 \text{ kN}$  i  $F_{y1} = 140 \text{ kN}$ ,
- Slučaj 3:  $F_z = 250 \text{ kN}$  i  $F_{y1} = 84 \text{ kN}$

Na slikama 8-19 prikazani su neki od rezultata proračuna točka železničkog vozila, dobijeni u programskom paketu ANSYS, za sva tri slučaja merodavnih opterećenja.

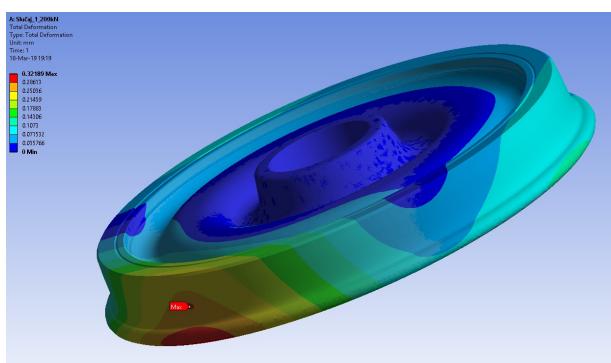

Slika 8. Ukupne deformacije za slučaj 1

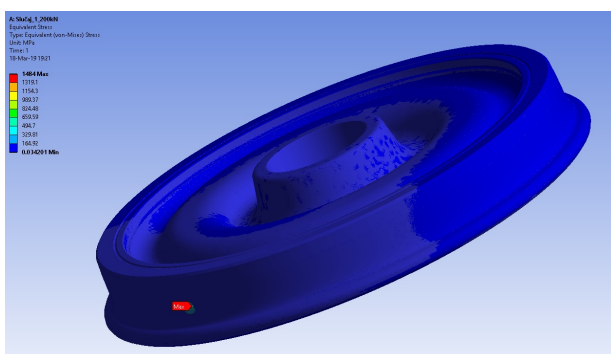

Slika 9. Ekvivalentni naponi za slučaj 1

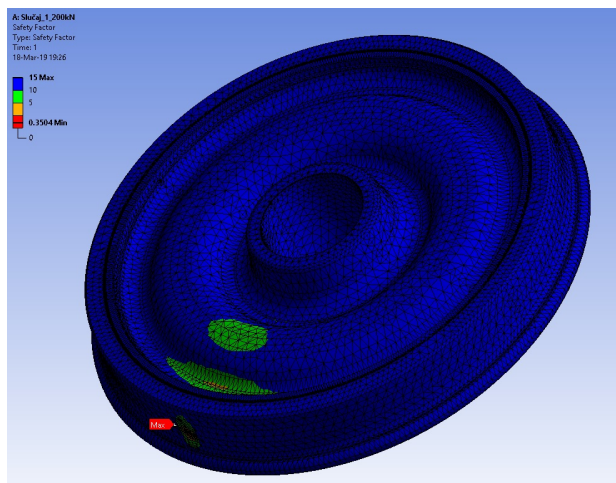

Slika 10. Statički stepen sigurnosti za slučaj 1

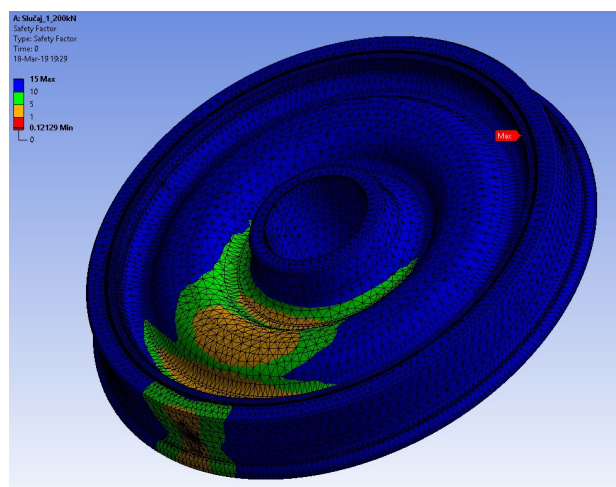

Slika 11. Dinamički stepen sigurnosti za slučaj 1

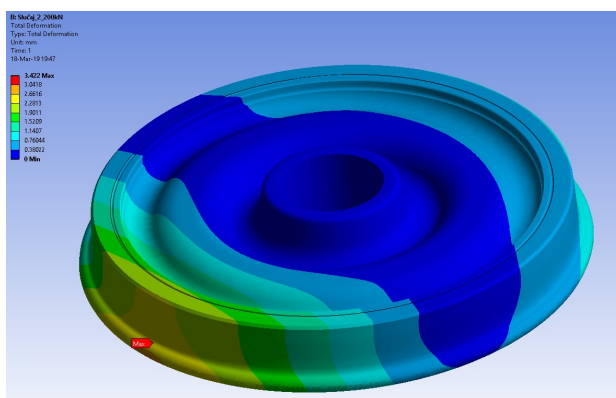

Slika 12. Ukupne deformacije za slučaj 2

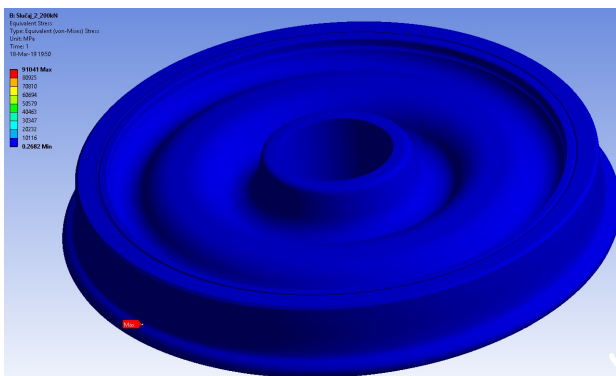

Slika 13. Ekvivalentni naponi za slučaj 2

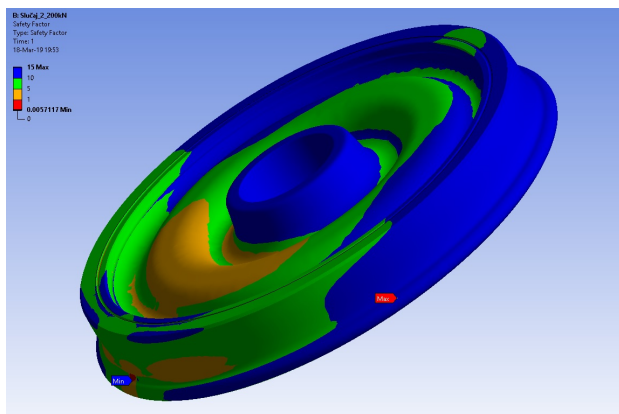

Slika 14. Statički stepen sigurnosti za slučaj 2

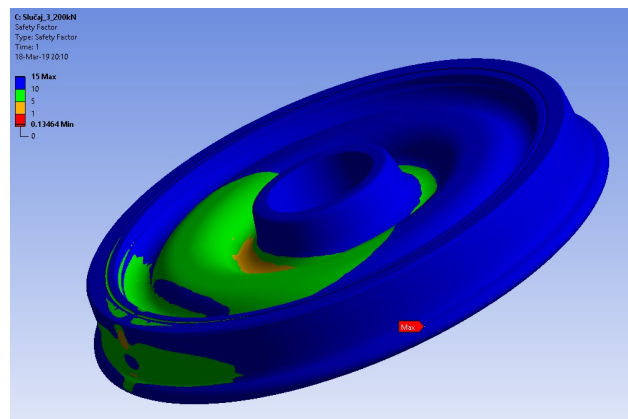

Slika 18. Statički stepen sigurnosti za slučaj 3

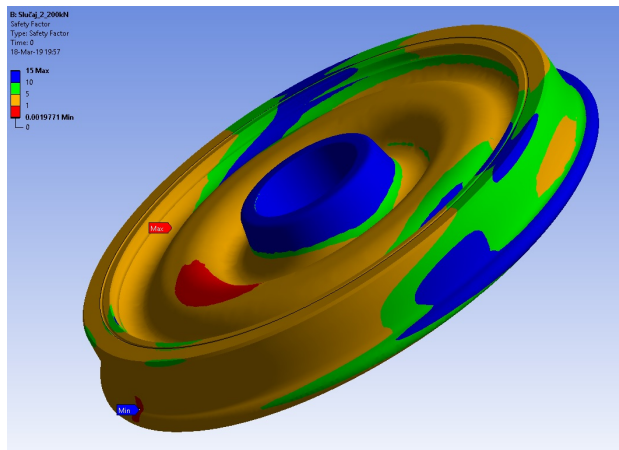

Slika 15. Dinamički stepen sigurnosti za slučaj 2

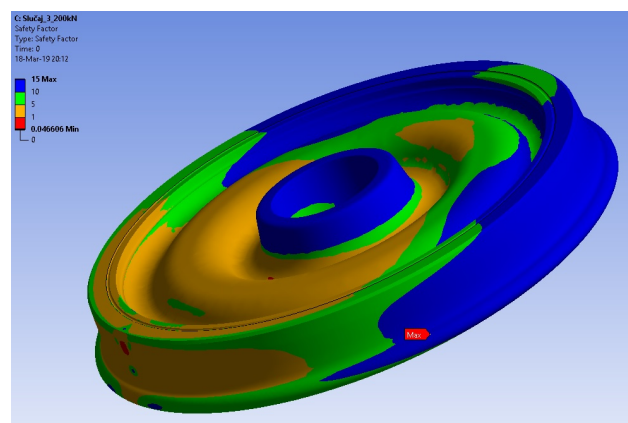

Slika 19. Dinamički stepen sigurnosti za slučaj 3

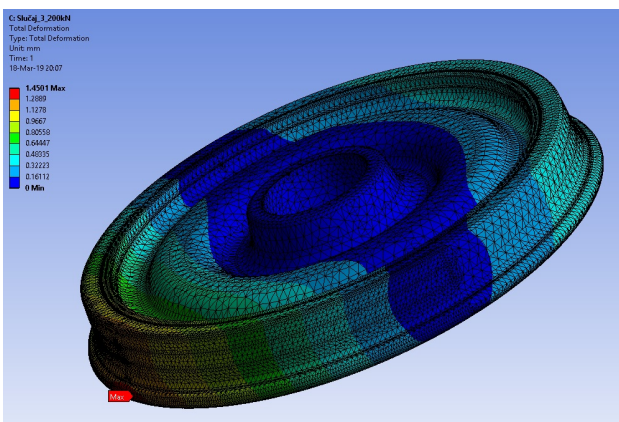

Slika 16. Ukupne deformacije za slučaj 3

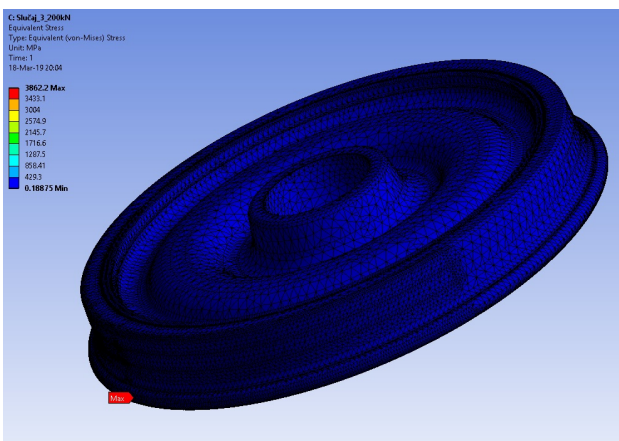

Slika 17. Ekvivalentni naponi za slučaj 3

## 5. ANALIZA DOBIJENIH REZULTATA

Dobijeni rezultati za sva tri slučaja opterećenja prikazani su u tabeli 2.

Tabela 2. Rezultati dobijeni metodom konačnih elemenata

		Slučaj 1	Slučaj 2	Slučaj 3
$\epsilon_{tot}$ [mm]	max	0,32189	3,422	1,4501
	min	0	0	0
$\sigma_{eq}$ [MPa]	max	824,48	91041	3862,2
	min	0,034201	0,2682	0,18875
$S_{st}$	max	15	15	15
	min	0,3504	0,0057117	0,13464
$S_{din}$	max	15	15	15
	min	0,12129	0,0019771	0,046606

U tabeli 2 su:

- $\epsilon_{tot}$  - Ukupne deformacije,
- $\sigma_{eq}$  - Ekvivalentni naponi,
- $S_{st}$  - Statički stepen sigurnosti,
- $S_{din}$  - Dinamički stepen sigurnosti.

Kao što se može videti u tabeli 2, najveći ekvivalentni napon i najveće ukupne deformacije se pojavljuju u drugom slučaju opterećenja. Drugim rečima, kod ovog slučaja opterećenja dobijaju se najmanje vrednosti statičkih i dinamičkih stepena sigurnosti, ali koje, u slučaju analiziranog točka, zadovoljavaju propisane granične vrednosti. Prema tome, točak trpi najveća opterećenja pri kretanju u krivinama.

## 6. ZAKLJUČAK

U radu je prikazana metodologija proračuna točkova železničkih vozila prema relevantnim međunarodnim standardima. Metodologija je demonstrirana na primeru monoblok točka teretnog vagona za osovinsko opterećenje 200 kN češke fabrike Bonatrans. Analiza rezultata proračuna pokazala je da statički i dinamički stepeni sigurnosti za sva tri slučaja merodavnih opterećenja zadovoljavaju propisane granične uslove. Prikazani pristup može se veoma uspešno primeniti sa ciljem smanjenja obima ili izbegavanja veoma skupih eksperimentalnih ispitivanja u ranim fazama razvoja i projektovanja železničkih točkova.

## LITERATURA

- [1] D. Petrović, V. Aleksandrov, *Železnička vozila – Osnove*, Fakultet za mašinstvo i građevinarstvo u Kraljevu, Kraljevo, 2013.
- [2] G.Simić, “Vagoni Konstrukcija i proračun”, Univerzitet u Beogradu- Mašinski fakultet , (2013), ISBN 978-86-7083-809-3
- [3] K. Kamberov, G. Todorov, S. Stoev and B. Romanov, “MECHANICAL STRENGTH TEST OF TRAIN WHEEL BASED ON VIRTUAL PROTOTYPING”, “Proceedings in Manufacturing System”, ISSN 2067-9238, Vol. 10, pp. 99–104, (2015)
- [4] S.H. Ju, “A frictional contact finite element for wheel/rail dynamic simulations“, “Springer Science + Business Media Dordrecht (2016),” 3 March 2016, Vol. 85, pp. 365-374, (2016)
- [5] A.E. Blanco-Saura, J.L. Velarte-Gonzalez, F. Ribes-Llario and J.I. Real-Herraiz, “Study of the dynamic vehicle-track interaction in a railway turnout”, “Springer Science + Business Media Dordrecht (2017),” 16 June 2017, p. 16, (2017)
- [6] M.A. Che Zulkifli, K.S. Basaruddin, M. Afendi, W.H. Tan and E.M. Cheng, “Finite Element Simulation on Railway Wheels under Various Loading”, IOP Conf. Series: Materials Science and Engineering 429, (2018)
- [7] P.K. Verma, S. Dixit and Dr.Y. Anand, “Combined Load Analysis of Re-Profiled Railway Wheel”, International Research Journal of Engineering and Technology (IRJET), Impact Factor value: 7.211, ISO 9001:2008 Certified Journal, (DEC 2018)
- [8] R.M. Nejad, “Using three-dimensional finite element analysis for simulation of residual stresses in railway wheels”, Engineering Failure Analysis 45, pp.449-455, (2014)
- [9] R.M. Nejad, K. Farhangdoost and M. Shariati, “Numerical study on fatigue crack growth in railway wheels under the influence of residual stresses”, Engineering Failure Analysis 52, pp.75-89, (2015)
- [10] R. Manivel and R. Shanmuga Prakash, “Material Optimization of Rail Track Welding and Validation using Finite Element Simulation”, International Journal of Vehicle Structures & Systems, pp. 91-94, (2017)
- [11] J. Xu, P. Wang, L. Wang and R. Chen, “Effects of profile wear on wheel- rail contact conditions and dynamic interaction of vehicle and turnout”, “Advances in Mechanical Engineering”, 13 January 2016, Vol. 8(1), p. 1-16, (2016)
- [12] M.Bižić, “Istraživanje uticajnih parametara u interakciji točak- šina na stabilnost kretanja železničkih vozila- doktorska disertacija”, Fakultet za mašinstvo i građevinarstvo u Kraljevu, Univerzitet u Kragujevcu, Kraljevo (2015), p.257
- [13] H.L.Whittemore and S.N.Petrenko, “Tables of Hertzian contact- stress coefficients”, “Coordinated scifnce laboratory”, University of Illinois-Urbana, Illinois (1921), p.201
- [14] S.Timošenko and J.N.Gudier, “Teorija elastičnosti- srpski prevod”, Građevinska knjiga-Beograd, (1962)

## Calculation of Strength of Railway Wheels

Vladimir Sindelić<sup>1\*</sup>, Milan Bižić<sup>1</sup>, Dragan Petrović<sup>1</sup>

<sup>1</sup> Faculty of mechanical and civil engineering of Kraljevo, University of Kragujevac, Kraljevo (Serbia)

*This paper presents a methodology for calculating strength of railway vehicles wheel, according to current international standards. The methodology is demonstrated by the example of monoblock wheel of a standard wheelset of a freight wagon for a axle load of 200 kN. Analysis of stress-strain states and static and dynamic safety factor of wheel was performed using the finite element method in the software package ANSYS. For determination sizes of contact surface at places where loads are placed, Hertz contact theory between two elastic bodies was applied. The obtained result showed that the analyzed wheel has the necessary safety factor and satisfies all the strength criteria defined by the standards.*

**Keywords:** Strength calculation, Railway vehicles, Monoblock wheel, Hertz contact theory, Finite element method

### 1. INTRODUCTION

The wheel of railway vehicle together with the axle is one of the most important parts through which the movement of the railway vehicle along the track is achieved. Wheels also suffer the entire load from the structure (box, underframe, bogie, etc.) of railway vehicle. During their exploitation in different working and weather conditions the wheels are exposed to dynamic loads which often have the character of extremely high intensity impact loads. Railway wheels are therefore subject to extremely high quality requirements. There are two basic variants of wheel making and this: hoop wheel and monoblock (one-part) wheel. The hoop wheel consists of a wheel body, hoop and safety ring. The monoblock wheel is made of one part of steel. For vehicles with a normal track speed exceeding 160 km/h the International Railway Union (UIC) only allows monoblock wheels. The reason for this is the risk of loosening of the hoops due to centrifugal force. Manufacturing a monoblock wheel is much simpler than a rim wheel, as it avoids surface treatment and hoop mounting. Also the mass of the monoblock wheel is smaller, since it consists of one part and its rim may be thinner than the wheel hoop [1, 2].

Given that wheels are dynamically and statically most loaded parts of railway vehicles and have a very responsible function, their defects can endanger the safety of movement. Therefore, it is necessary to perform a proper calculation of wheel strength.

Nowadays experimental check of railway vehicle wheels has an alternative in calculations and simulations in sophisticated software tools. These tools provide engineers with a number of assessments in early – initial stages of developing a railway wheel. This process provides an effective way to reduce the cost of prototyping and to obtain a cost-effective solution, and to shorten the time to outlet a product – wheel to market. It also provides an additional advantage in product design which is reflected in the ability to analyze structural behavior to improve product (wheel) performance [3].

Mainly the finite element method (FEM) is used for these purposes, as one of the methods of software analysis of machine structures, which enables analysis of the product from the early stages of development and production [4-5]. This method has been used successfully

for many years in the analysis of the strength of elements of railway vehicles.

Using the finite element method three dimensional models are developed that allow the calculation of mechanical loads at any point in the wheel, and the results obtained show a good agreement with the real values obtained by the experimental tests [6]. In a similar way, it is possible to model and analyze the temperature distribution at wheels of different radius, wheel temperatures for different values movements of the railway velocity, as well as stresses distribution for different wheel loads [7]. Also, the finite element method enables the analysis of residual stresses in the wheels of movements of the railway velocity caused by stresses due to the heat treatment of the wheel [8]. In same studies the finite element method was used to prevision the growth of material fatigue on railway wheels and the interest of residual stresses, and the results obtained showed good agreement with the filed measurements achieved [9]. The finite element method has also proved very successful in the simulations and load calculations of railway rails [10], as well as contact stresses and wear analysis of wheel and rail profiles [11].

In this paper, applying the finite element method, the calculation of the strength of a standard monoblock wheel of axle of freight wagon for normal track width and axle load of 200 kN, is performed. The material of the wheel analyzed is ER7 (label according to European regulations EN), or R7 (label according to UIC regulations).

The basic aim in the paper is to demonstrate application of the finite element method in the calculation of the strength of railway wheels, as well as to present a modern methodology for calculating the strength of wheels of railway vehicles, which in most cases avoids very expensive and time consuming experimental testing.

### 2. METHODOLOGY OF WHEEL STRENGTH CALCULATION

The wheel calculation procedure is performed in two stages. The first stage involves calculation under defined conditions, and the second stage involves fatigue test and it is carried out only if the first stage fails to produce satisfactory results. The calculations give the stress at various points in the wheel body, which are

\* Corresponding author: Dositejeva 19, 36000 Kraljevo, email:vladimir.sindjelic@gmail.com

compared to the permissible stress by certain procedure. If the design stress is within the allowed limits, there is no risk of fatigue cracking and the wheel is considered to be correctly dimensioned. If the calculated stress is outside the allowed limits, dimension changes need to be made on the body of the wheel and repeat the calculation until the stress are within the allowed limits. An algorithm for the complete wheel calculation procedure is given in the figure 1 [2].

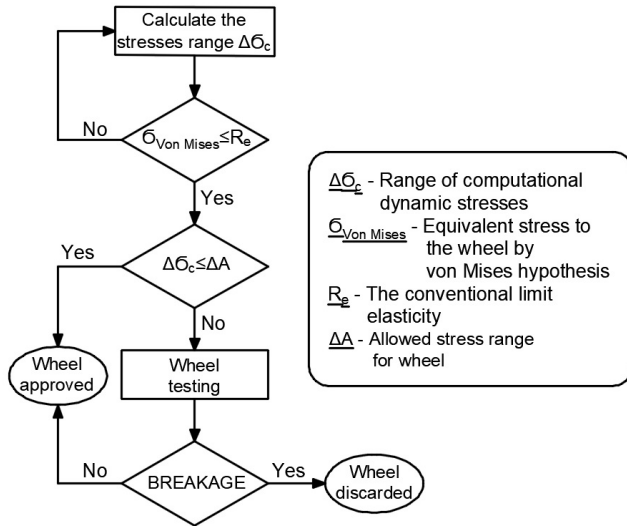

Figure 1. Algorithm for calculation the strength of the wheel

### 2.1. Relevant loads for wheel calculation

The procedure for determining the relevant loads is based on three classic cases: when wheel movement is on the straight track; when a railway vehicle moves through a curve; and when movement or crossing over a shunt and an intersection is included (standard EN 13979-1).

In the first case only the vertical force acts  $F_z$  from the rail on a nominal rolling circle at 70 mm from the back of the wheel, while the vertical reaction is calculated according to the following expression (Figure 2):

$$F_z = 1,25 \cdot N \quad (1)$$

In the second case, the vertical force  $F_z$  acts at the root of the flange of the leading wheel at a distance of 38 mm from the back of the wheel, and the lateral force  $F_{y1}$  acts on the rim of 10 mm below the nominal rolling circle, and the form were given by equation (Figure 2):

$$F_z = 1,25 \cdot N \quad (2)$$

$$F_{y1} = 0,7 \cdot N \quad (3)$$

In the third case, the leading wheel is in the channel, at losing the wheel rim support, and provisionally guidance of the wheelset takes over the opposite wheel which relies internally on the guide rail. Lateral force  $F_{y2}$  then acts on the back of the wheel at a distance 10 mm from below of the rolling circle, and the vertical force  $F_z$  acts nearer to the outside of the wheel on the 105 mm from the back. The equations for this case are as follows (Figure 2):

$$F_z = 1,25 \cdot N \quad (4)$$

$$F_{y2} = -0,42 \cdot N \quad (5)$$

In all three cases,  $N$  represent static load by wheel.

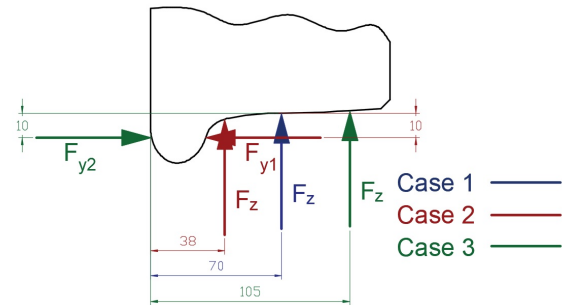

Figure 2. Load cases for wheel calculation

### 3. DETERMINATION OF THE SIZE OF CONTACT SURFACES

In the contact surface between the wheel and the rail they are very intense forces of action and reaction which have a key influence on the dynamic behavior of railway vehicles and tracks. These forces play a key role in reliance, guidance, pull and braking railway vehicles while moving around the track [12].

Solving a normal contact problem between wheel and rail is based on Hertz static contact theory of two elastic bodies. Hertz theory can be applied under the following assumptions: displacement and deformation are small size, the contact area is small compared to the wheel and rail dimensions, apropos it is small relative to the radius of the wheel, the area near the contact surface is described by a constant curve, the contact surfaces are smooth, roughness is ignored, there are only elastic deformations and material of the wheel and rail is homogeneous and isotropic [12]. According to Hertz, contact surface is the shape of an ellipse with half axis  $a_e$  and  $b_e$  (Figure 3).

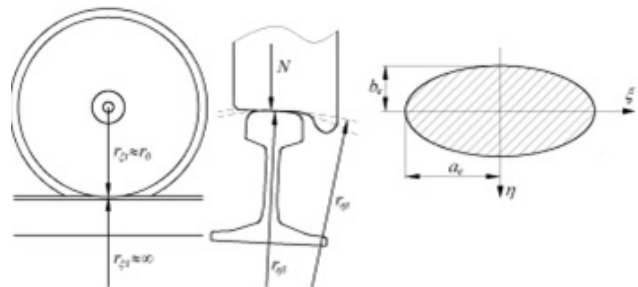

Figure 3. Contact surface between wheel and rail according to Hertz theory [12]

The half axis ellipse is calculated according to the following expression:

$$a_e = m \cdot \sqrt[3]{\frac{3}{2} \cdot \frac{N(1-\nu_p^2)}{E(A+B)}} \quad (6)$$

$$b_e = n \cdot \sqrt[3]{\frac{3}{2} \cdot \frac{N(1-\nu_p^2)}{E(A+B)}} \quad (7)$$

In equations (6) and (7)  $E$  is modulus of elasticity,  $\nu_p$  is the Poisson's coefficient,  $N$  is normal force,  $A$  and  $B$  are functions that depend on radius of curvature of wheel in the longitudinal direction  $r_{et}$ , radius of curvature of wheel in the transverse direction  $r_{nt}$ , radius of curvature



of rail in the longitudinal direction  $r_{\varepsilon s}$  and radius of curvature of rail in the transverse direction  $r_{\eta s}$ , and they can be calculated according to the following equations:

$$A = \frac{1}{2} \left( \frac{1}{r_{\eta s}} - \frac{1}{r_{\eta t}} \right) \quad (8)$$

$$B = \frac{1}{2} \left( \frac{1}{r_{\varepsilon s}} + \frac{1}{r_{\varepsilon t}} \right) \approx \frac{1}{2r_{\varepsilon t}} \approx \frac{1}{2r_0} \quad (9)$$

Sizes  $m$  and  $n$  represent constants that are determined from the tables, based on equation [12]:

$$\theta = \cos \left( \frac{A-B}{A+B} \right) \quad (10)$$

The contact area of the wheel and rail is:

$$A_e = \pi \cdot a_e \cdot b_e \quad (11)$$

### 3.1. Calculation of sizes of contact surfaces for load introducing

For calculation the size of contact surfaces, the rail UIC 60 was used (Figure 4).

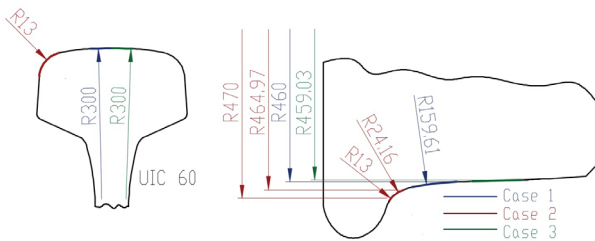

Figure 4. Value for radius of curves of the rail and the wheel

The wheel load is  $N = 200 \text{ kN}$ , wheel and rail elastic modulus is  $E = 210 \text{ kN/mm}^2$  and the Poisson's ratio is  $\nu_p = 0,3$ .

The radius of curves for the first case are:  $r_{\varepsilon t} = 460 \text{ mm}$ ,  $r_{\eta t} = 159,61 \text{ mm}$ ,  $r_{\varepsilon s} = \infty$ ,  $r_{\eta s} = 300 \text{ mm}$ .

In the second case, wheel-rail contact is realizes on two contact wheel surface with different radius so in the first contact region we have:  $r_{\varepsilon t} = 464,97 \text{ mm}$ ,  $r_{\eta t} = -24,16 \text{ mm}$ ,  $r_{\varepsilon s} = \infty$  and  $r_{\eta s} = 13 \text{ mm}$ , and in the second region:  $r_{\varepsilon t} = 470 \text{ mm}$ ,  $r_{\eta t} = -13 \text{ mm}$ ,  $r_{\varepsilon s} = \infty$  and  $r_{\eta s} = 13 \text{ mm}$ .

In the third case of contact, the radius values are:  $r_{\varepsilon t} = 459,03 \text{ mm}$ ,  $r_{\eta t} = \infty \text{ mm}$ ,  $r_{\varepsilon s} = \infty$  and  $r_{\eta s} = 300 \text{ mm}$ .

The calculated values of contact surfaces for introduction of load on the wheel are shown in the table 1.

Table 1. Calculated values of contact surfaces

	I	II <sup>1</sup>	II <sup>2</sup>	III
$m$	1,17232	2,8932	0	1,1566
$n$	0,6481	0,4777	0	0,8732
$a_e \text{ (mm)}$	10,4163	11,8664	0	9,0031

$b_e \text{ (mm)}$	3,9177	1,9592	0	6,7970
$A_e \text{ (mm}^2\text{)}$	128,2023	73,0360	0	192,2474

## 4. WHEEL CALCULATION

Based on the technical documentation of the Bonatrans factory, a three-dimensional wheel geometry was formed. This geometry is imported in software package ANSYS in which the discretization was made and calculation model was formed using the finite element method. Way to model the contact surfaces determined in previous chapter in model is shown in the figure 5. The loads defined in chapter 2 are introduced in these surfaces. The calculation model of the wheel contains 224500 nodes and 132995 finite elements (figure 6).

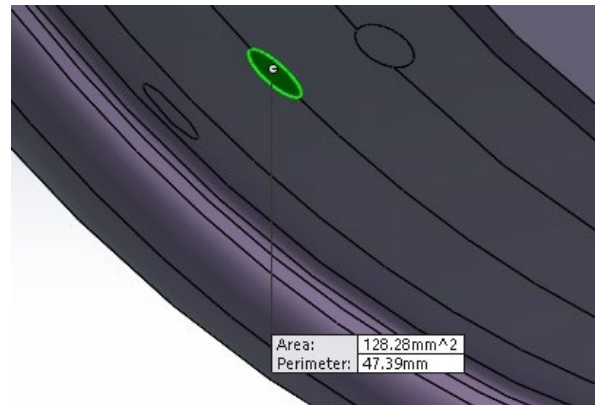

Figure 5. Model of the wheel with contact surfaces where loads are introduced

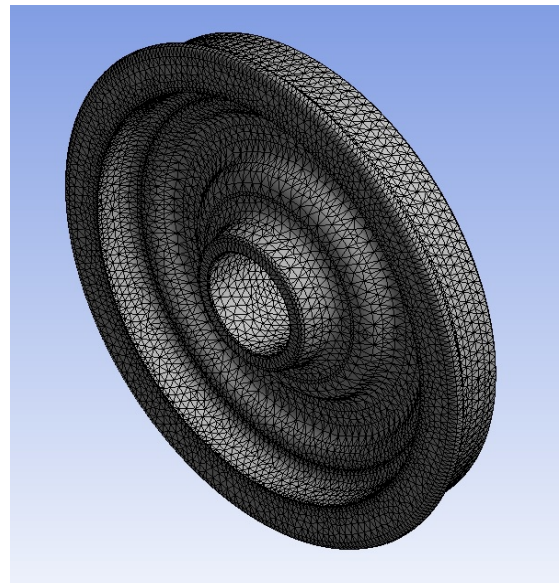

Figure 6. Wheel model of 224500 nodes and 132995 finite elements

Place of joint of wheel hub with axle is modeled as a fixed support, i.e. it was assumed that there is no any displacement at the joint with the axle (figure 7).

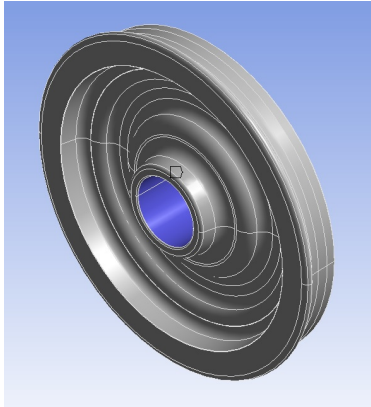

Figure 7. Fixed support at the place of connection of wheel hub with axle

For given wheel material ER7, in the software package ANSYS the following values of parameters for wheel material are specified:  $R_{eh} = 520 \text{ N/mm}^2$  and  $R_m = 820 \text{ N/mm}^2$ , where  $R_{eh}$  is yield strength and  $R_m$  is tensile strength.

In aim of the dynamic calculation, in software package ANSYS, appropriate wheel material parameters were entered. The endurance limit for machined wheel body which corresponds to a number of 10 million stress change cycles is  $180 \text{ N/mm}^2$  [2].

The force values calculated according to Chapter 2 for all three load cases are:

- Case 1:  $F_z = 250 \text{ kN}$ ,
- Case 2:  $F_z = 250 \text{ kN}$  and  $F_{y1} = 140 \text{ kN}$ ,
- Case 3:  $F_z = 250 \text{ kN}$  and  $F_{y1} = 84 \text{ kN}$

On figures 8-19, some of the results of the calculation of the wheel of a railway vehicle are shown, obtained in the software package ANSYS, for all three cases of relevant loads.

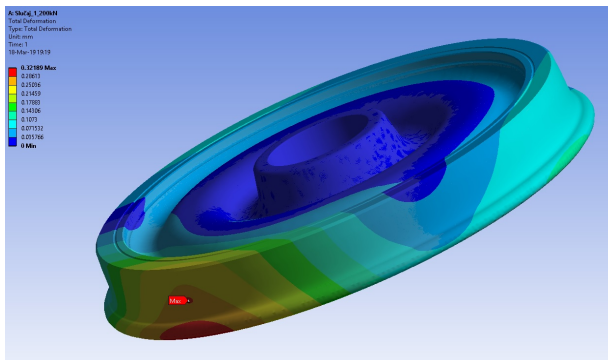

Figure 8. Total deformations for case 1

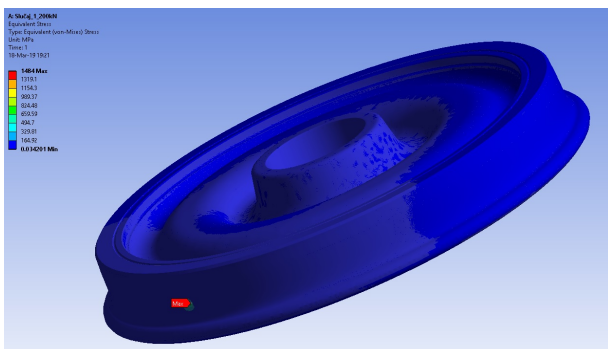

Figure 9. Equivalent stress for case 1

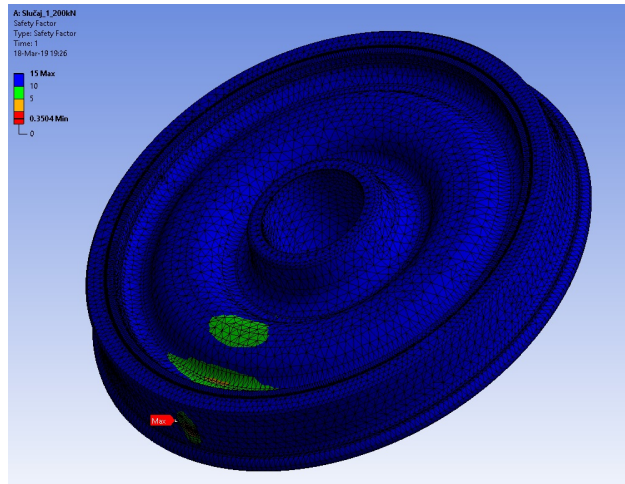

Figure 10. Static safety factor for case 1

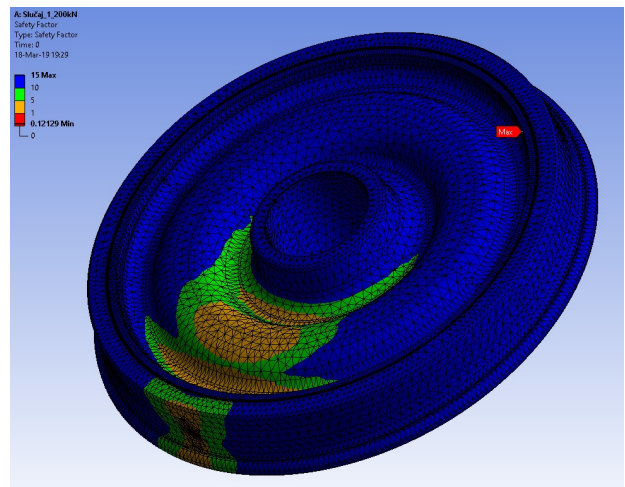

Figure 11. Dynamic safety factor for case 1

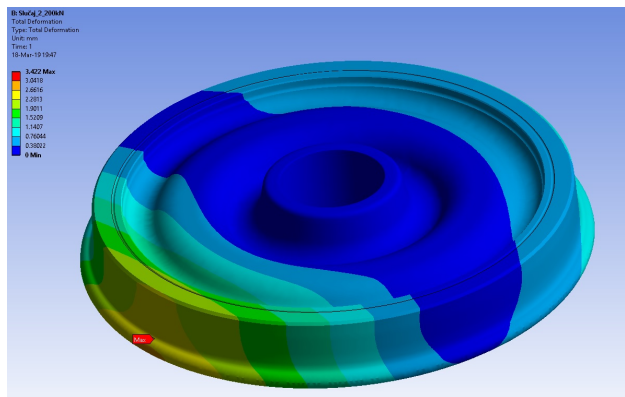

Figure 12. Total deformations for case 2

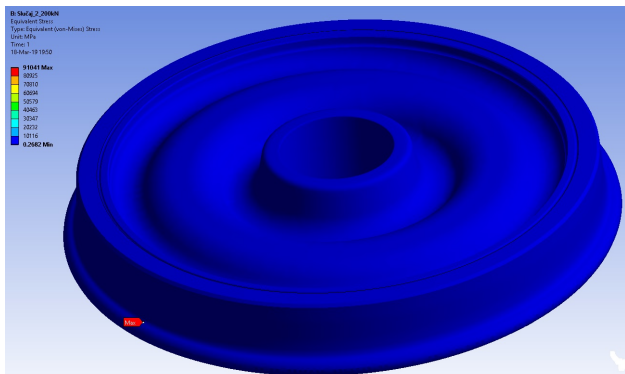

Figure 13. Equivalent stress for case 2

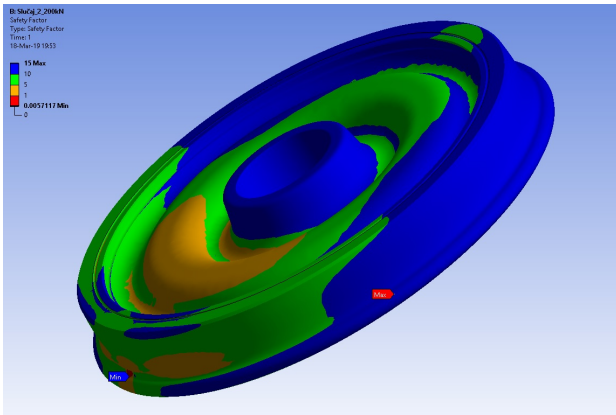

Figure 14. Static safety factor for case 2

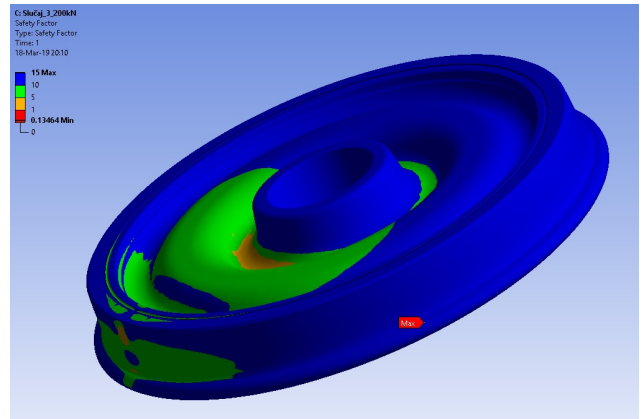

Figure 18. Static safety factor for case 3

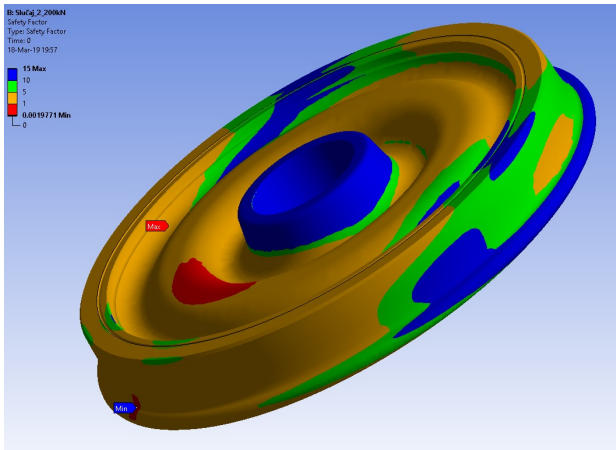

Figure 15. Dynamic safety factor for case 2

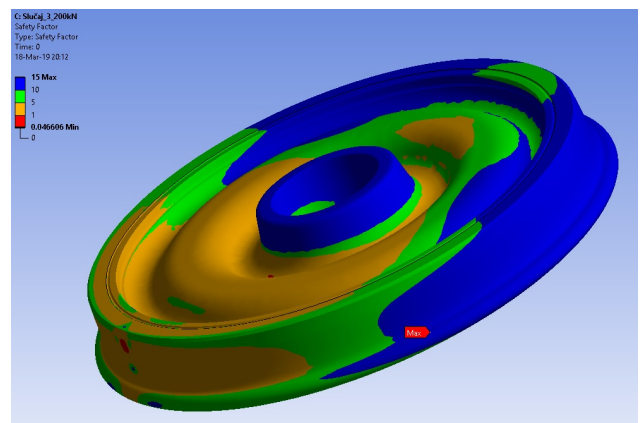

Figure 19. Dynamic safety factor for case 3

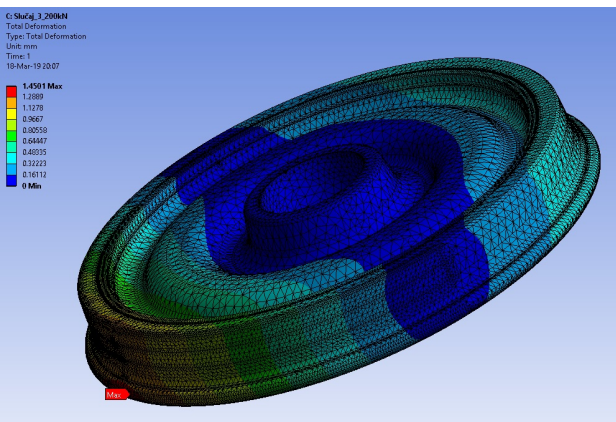

Figure 16. Total deformations for case 3

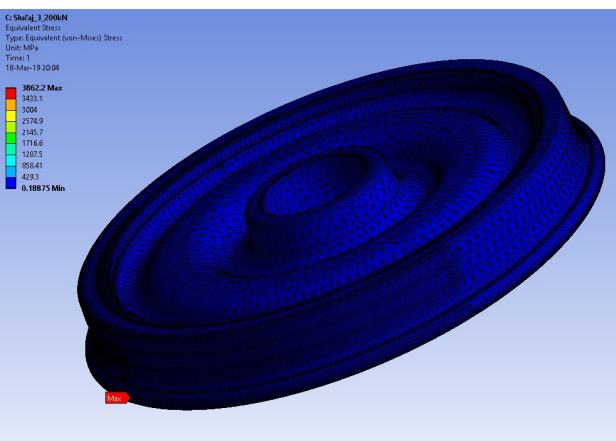

Figure 17. Equivalent stress for case 3

### 5. ANALYSIS OF RESULTS

The obtained results for all three load cases are shown in table 2.

Table 2. Results obtained by the finite element method

		Case 1	Case 2	Case 3
$\epsilon_{tot}$ [mm]	max	0,32189	3,422	1,4501
	min	0	0	0
$\sigma_{eq}$ [MPa]	max	824,48	91041	3862,2
	min	0,034201	0,2682	0,18875
$S_{st}$	max	15	15	15
	min	0,3504	0,0057117	0,13464
$S_{din}$	max	15	15	15
	min	0,12129	0,0019771	0,046606

In the previous table are:

- $\epsilon_{tot}$  - Total deformation,
- $\sigma_{eq}$  - Equivalent stress,
- $S_{st}$  - Static safety factor,
- $S_{din}$  - Dynamic safety factor.

As can be seen in the table 2, maximum equivalent stress and maximum total deformation appear in the second load case. In other words, in this load case the least values of static and dynamic safety factor are obtained, but which are in the case of the analyzed wheel, satisfy the limit values. According, the wheel is exposed to the greatest loads when movement in curves.

## 6. CONCLUSION

This paper presents methodology of calculation of railway wheels according to relevant international standards. The methodology was demonstrated at example of a monoblock wheel of freight wagon for axle load 200 kN made of Czech factory Bonatrans. The analysis of the results of the calculation showed that the static and dynamic safety factor for all three cases of relevant loads satisfy prescribed boundary conditions. The approach presented can be very successfully applied to reduce the extent or avoiding very expensive experimental tests in the early stages of development and design of railway wheels.

## REFERENCES

- [1] D. Petrović, V. Aleksandrov, *Železnička vozila – Osnove*, Fakultet za mašinstvo i građevinarstvo u Kraljevu, Kraljevo, 2013.
- [2] G.Simić, “Vagoni Konstrukcija i proračun”, Univerzitet u Beogradu- Mašinski fakultet , (2013), ISBN 978-86-7083-809-3
- [3] K. Kamberov, G. Todorov, S. Stoev and B. Romanov, “MECHANICAL STRENGTH TEST OF TRAIN WHEEL BASED ON VIRTUAL PROTOTYPING”, “Proceedings in Manufacturing System”, ISSN 2067-9238, Vol. 10, pp. 99–104, (2015)
- [4] S.H. Ju , “A frictional contact finite element for wheel/rail dynamic simulations“, “Springer Science + Business Media Dordrecht (2016),” 3 March 2016, Vol. 85, pp. 365-374, (2016)
- [5] A.E. Blanco-Saura, J.L. Velarte-Gonzalez, F. Ribes-Llario and J.I. Real-Herraiz, “Study of the dynamic vehicle-track interaction in a railway turnout ”, “Springer Science + Business Media Dordrecht (2017),” 16 June 2017, p. 16, (2017)
- [6] M.A. Che Zulkifli, K.S. Basaruddin, M. Afendi, W.H. Tan and E.M. Cheng, “Finite Element Simulation on Railway Wheels under Various Loading”, IOP Conf. Series: Materials Science and Engineering 429, (2018)
- [7] P.K. Verma, S. Dixit and Dr.Y. Anand, “Combined Load Analysis of Re-Profiled Railway Wheel”, International Research Journal of Engineering and Technology (IRJET), Impact Factor value: 7.211, ISO 9001:2008 Certified Journal, (DEC 2018)
- [8] R.M. Nejad, “Using three-dimensional finite element analysis for simulation of residual stresses in railway wheels”, Engineering Failure Analysis 45, pp.449-455, (2014)
- [9] R.M. Nejad, K. Farhangdoost and M. Shariati, “Numerical study on fatigue crack growth in railway wheels under the influence of residual stresses”, Engineering Failure Analysis 52, pp.75-89, (2015)
- [10] R. Manivel and R. Shanmuga Prakash, “Material Optimization of Rail Track Welding and Validation using Finite Element Simulation”, International Journal of Vehicle Structures & Systems, pp. 91-94, (2017)
- [11] J. Xu, P. Wang, L. Wang and R. Chen, “Effects of profile wear on wheel- rail contact conditions and dynamic interaction of vehicle and turnout”, “Advances in Mechanical Engineering”, 13 January 2016, Vol. 8(1), p. 1-16, (2016)
- [12] M.Bižić, “Istraživanje uticajnih parametara u interakciji točak- šina na stabilnost kretanja železničkih vozila- doktorska disertacija”, Fakultet za mašinstvo i građevinarstvo u Kraljevu, Univerzitet u Kragujevcu, Kraljevo (2015), p.257
- [13] H.L.Whittemore and S.N.Petrenko,“Tables of Hertzian contact- stress coefficients”,“Coordinated science laboratory”,University of Illinois-Urbana,Illinois (1921),p.201
- [14] S.Timošenko and J.N.Gudier, “Teorija elastičnosti-srpski prevod”, Građevinska knjiga-Beograd, (1962)