

Oleg E. Markov

Professor,
Department of Computerized Design and
Modeling of Processes and Machines,
Donbass State Engineering Academy,
Ukraine

Volodymyr V. Kukhar

Professor,
Department of Metal Forming,
Pryazovskiy State Technical University,
Ukraine

Vitalii N. Zlygoriev

PhD,
Private Joint Stock Company
"Novokramatorsky Mashinostroitelny Zavod",
Ukraine

Alexander A. Shapoval

Docent,
Department of Manufacturing Engineering,
Kremenchuk Mykhailo Ostohradskiy
National University,
Ukraine

Anton S. Khvashchynskiy

Assistant,
Department of Computerized Design and
Modeling of Processes and Machines,
Donbass State Engineering Academy,
Ukraine

Roman U. Zhytnikov

Assistant,
Department of Computerized Design and
Modeling of Processes and Machines,
Donbass State Engineering Academy,
Ukraine

Improvement of Upsetting Process of Four-Beam Workpieces Based on Computerized and Physical Modeling

The method of upsetting of large ingots has been investigated in this work. The proposed method consists in upsetting of profiled workpieces with concave faces. An angle of the concave faces was 150°. A relative depth of the concave faces has been varied in range 15%...25% from workpiece's diameter. Strains effective and mean stresses in the longitudinal cross-section of the workpiece with concave faces after upsetting have been determined by FEM. A value of compressive stresses has been determined based on a parameter of the stress state. FEM allowed to find what a rational depth of the concave faces should be, which has to be 15 % from workpiece's diameter. Maximum closing of the internal defect take place for this depth of the concave faces. Results of the FEM have been tested by experimental investigations. It has been established that upsetting of the four-beam workpieces improved a quality of the massive parts.

Keywords: forging, upsetting, ingot, internal defect, four-beam workpiece

1. INTRODUCTION

Competing in the international markets of large machines requires higher quality and lower production costs of manufactured products. Large parts are made by forging ingots in heavy engineering. The ingot's metal has low mechanical properties, which are a consequence of the dendritic structure and shrinkage defects [1].

Destruction of the dendritic structure and welding of the shrinkage defects will allow to improve the quality of the large forged workpieces. It is necessary to produce forgings with high forging ratio in this case. An upsetting operation in the forging technological process is used to increase the forging ratio. However, an influence of the upsetting operation to the welding of the shrinkage defects is ambiguously and is known a conflicting information on this subject.

The improvement of the upsetting operation, which can be done by changing the shape of the upsetting workpieces is the current direction of research. The upsetting of the workpieces with a special shape will allow to change strain and stress state for increasing of breaking of the cast structure and welding of the shrinkage defects [2].

2. LITERATURE REVIEW

In the development and design of technological processes a manufacturing of large forged parts are aimed for the search of rational upsetting method to increase the metal structure breaking. Main localization of the shrinkage defects in the large parts appears in an axial zone. It is due to the corresponding stress-strain state (SSS) during deformation. Usage of the upsetting operation and a drawing operation increases uniformity of the mechanical properties but it also increases the laboriousness and power consumption of the forging process.

Quantity of the large forged parts manufactured from ingots has been increased in recent years. It is explained by increasing of a heavy machines power. However, the quality of manufactured forgings does not always correspond to customer requires. A low quality of the large forged parts is explained by low quality of forging ingots [3, 4].

The need for large forged parts manufactured using of the upsetting operation has grown in lately as has been shown by authors in the paper [5]. The quality of these forgings is defined by the mechanical properties and a degree of metal structure heterogeneity. The applicable processes of the large parts forging does not guarantee an obtaining of the high quality.

The special methods of the large parts forging have been reviewed in the paper [6]. These forging methods differ by the type of used operations, deformation regi-

Received: April 2020, Accepted: July 2020

Correspondence to: Prof. Oleg E. Markov
Donbass State Engineering Academy, Akademichna
(Shkadinova) Str. 72, 84313 Kramatorsk, Ukraine
E-mail: oleg.markov.ond@gmail.com

doi:10.5937/fme2004946M

© Faculty of Mechanical Engineering, Belgrade. All rights reserved

FME Transactions (2020) 48, 946-953 946

mes and dies geometry [7]. The mechanical properties of the parts mainly depend on using of the upsetting operation and further drawing operation. The primary interest is the improvement of the upsetting operation during design of deformation effective processes.

An increase of a forging production with high quality requires the development and introduction of new forging processes with low costs as has been noted in paper [8]. However, the new upsetting methods which allow to decrease a deformation force were not investigated in the paper. The deformation by special tool or changing of workpiece cross-section allows to decrease an upsetting force [9].

The main forging defect after upsetting is an axial porosity, which are determined by ultrasonic test [10]. The occurrence of this defect is explained by an unfavorable SSS during workpiece upsetting with a cylindrical shape by means appearance of a radial flow metal leading to internal cracks of the workpiece metal.

The authors of the paper [11] have developed the original model which described the voids closing and taking into account voids orientation and strain state of the workpieces. The model has been developed and checked based on significant number of experiment by finite element method (FEM).

However, the large forging ingots have the shrinkage defects elongated shape. Therefore these defects should be better modeling as an axial hole. Thus, developed model is not an universal for modeling a closing of axial porosity.

Authors in the article [12] have proposed method and tool for upsetting of a disk with ledge. The upsetting is produced with using of a disk's field deformation. A disadvantage of this upsetting method is the tool does not cover the disc's field. Non-deformed zones with a fold are occurred. It leads to increase of a metal consumption during cutting.

The internal defects closing during workpieces upsetting using flat dies with various geometry have been investigated by FEM [13]. A deformation degree has a large influence to the closing internal defects with comparison a hydrostatic stress as has been found by authors based on FEM. Obtained results contradict with a known data of other researchers [14] which claim that axial defects degree depend from SSS in the forging's body.

A fine-grained structure can be obtained by using rounding and upsetting operations. Workpieces faces have a conical shape before upsetting in this case [15]. However, obtaining of the workpiece faces with conical shape is a very difficult process. Moreover, the SSS and the closing mechanism of the internal defects during forging have not been determined in the work.

The authors of papers [16, 17] have investigated an influence of the hydrostatic stress as a parameter for estimation of the internal defects closing. However, authors have not analyzed a strain distribution in the workpiece volume during forging. The closing degree of the internal defects can be estimated on the base of a comprehensive account of the stresses and strains of the workpiece during deformation.

The closing mechanism of the internal defects with spherical shape has been investigated in paper [18]. The authors have investigated an influence of dimensions on

the closing defects. The SSS around of the internal defects is a main parameter which influences on it closure as the result has been found. Model for forecasting of the closing defects into the large forged workpieces has been proposed based on the results finite element simulation. The main disadvantage of this investigation is the use of simulated defects with spherical shape but axial defects into ingots have an elongated shape.

The strain distribution during forging operation of cylindrical workpieces at different forging ratio has been investigated in the paper [19]. A mathematical relationship of crack appearing on workpiece lateral area has been established. Developed recommendations, which improve, the surface quality for massive forgings have been shown in the works [20, 21]. However, a stress state influence on the surface crack formation has not been considered in these papers though this parameter is a significant scientific problem at realization ingots upsetting operation.

Two methods of dimension changing of the axial defects into ingot during forging have been compared in [22]. These methods take into account a damage accumulation at plastic deformation based on using of porous material model. It was found that a cut angle of a bottom die have to in range $90...120^\circ$ for an intensive welding of the ingots axial defects. However, the investigated schemes do not provide the appearance an uniform strain into workpiece's body.

A high uniform strain needs to provide during forging of the massive ingots to guarantee a mechanical properties uniform. The internal defects welding of the ingots during upsetting appears at condition of the hydrostatic stress. Today, used upsetting methods do not ensure an enough level of the hydrostatic compression in the ingot's axial zone to increase a density of forged metal [23].

The drawing operation before workpiece upsetting need to use for welding of the ingot's axial defects as in the paper [24] has been investigated. The authors have proposed a parameter for estimate of defects welding degree during hot deformation accounting an irregularity of stress distribution at the upsetting operation. The upsetting operation without using of the drawing operation during forging process increases the dimensions of the axial defects. An influence of dies shape for uniformity increasing of metal forged structure has not been established in the paper.

Main parameter, which determines the formation of the forged structure and mechanical properties of the part, is a forging ratio according to the authors of paper [25, 27]. However, analyze of forging different variants need to realize based on data of strain distribution in the workpiece's volume. It has not been done in this work.

A typical defect of the forged workpieces when upsetting operation using is a porosity of the forging's axial zone which is determined by ultrasonic test (UST). The reason offormation of workpiece's axial porosity can be using of the workpiece upsetting.

Based on a literature review, it has been found that the improvement of technological processes with using of a special method of workpiece's upsetting have a significant meaning for science and practice. This aspect

confirms a relevance of these investigations. Moreover, an existing methods of upsetting do not provide a high and uniformity mechanical properties of the part's axial zone. It is explained by an incomplete closing of the internal defects and this aspect requires of additional investigations in this direction.

One of the direction of forging improvement is workpieces profiling before upsetting by formation a concave faces on the workpiece's lateral surface [27]. The concave faces with an angle of 120° contribute to the incomplete closure of axial porosity. Increasing of the faces depth can decrease a welding degree of internal defects.

Therefore, it is necessary to conduct a further investigation to determine of an effective angle and depth of the workpiece's concave faces allowing to intensification a closing of the internal defects [27].

3. INVESTIGATION TECHNIQUE OF WORKPIECES UPSETTING WITH CONCAVE FACES

The aim of the work is to increase the mechanical properties for parts with responsible destination by means of welding of the internal defects, and improvement of ingot's structure by upsetting of the four-beam workpieces. These are the following tasks in this research:

- an shape influence of the four-beam workpieces to strain and stress distribution, and welding of the internal defects after upsetting needs to be determined;
- a new scientifically-based method of the workpieces upsetting with concave faces, which increases a density of the parts structure needs to be developed;
- an approbation of improved upsetting process of four-beam workpieces needs to be introduced.

3.1 Theoretical investigation by FEM

The modeling process of workpieces upsetting with concave faces has been conducted by FEM. A distribution of workpiece's SSS and reshaping of the axial defects after upsetting has been determined based on results of the modeling. All workpieces after profiling have been deformed with reduction to 50% from height.

An equation of relation between stresses and strain rates has been used

$$S_{ij} = \frac{2\bar{\sigma}}{3\bar{\epsilon}} \dot{\epsilon}_{ij} \quad (1)$$

The workpieces for FE modeling had dimensions (Fig. 1): diameter along ledge $D = 1.5$ m; workpiece's height $H = 3.75$ m; defect's hole diameter was 10% from a workpiece's maximum diameter ($d_0 = 0.15$ m); angle of the concave faces was 150° . The relative depth of the concave faces ($h = d/D$) has been investigated in range 15%, 20% and 25% from workpiece's diameter.

The model's material is steel 70Cr3NiMo; the heating temperature of the workpiece is 1150°C ; the temperature of dies is 20°C ; the friction coefficient is 0.45; amount of elements – is 75 000; the velocity of deformation is 35 mm/s. Value and sing of the stress can determine by means a parameter of the stress state

$$\Pi_\sigma = \frac{3\sigma_0}{\sigma_i} \quad (2)$$

This parameter has been determined in the workpiece's axial zone.

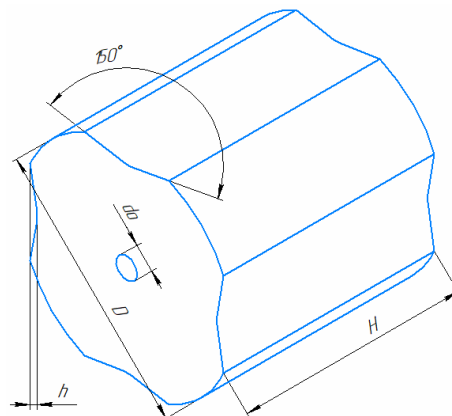

Figure 1. 3D-model of the workpiece with concave faces and axial defect

3.2 Experimental investigations

The cylindrical specimens from lead with diameter of 50 mm and height of 70 mm for experimental investigations have been made. A hole with diameter of 5 mm on workpiece end into axial zone has been drilled. The hole has been simulated an ingot's axial defect.

The forging of obtained workpieces has been carried out by convex dies. An angle of the convex die with wedge shape is equal to 150° . Measurements cross-section of the axial defects have been carried during profiling process. The defect's hole has been connected with to the laboratory burette. The changing of a water level into burette has been allowed to determine a current volume of the defects during upsetting operation and also its average diameter.

Profiled workpieces on cross-section with concave faces have been upsetted by flat plates with reduction of 70% with a phased fixing (each 5 mm) of the defect's volume. The investigation of defects closing additionally has been conducted for steel specimens (70Cr3NiMo). The steel specimens have been heated until temperature of 1150°C and were profiled by convex dies to four-beam cross-section with subsequent upsetting.

4. RESULTS OF FE MODELING OF THE UPSETTING OPERATION OF THE PROFILED WORKPIECES WITH CONCAVE FACES

4.1 Closing of the workpiece's defect

The depth of the concave faces during upsetting of the four-beam workpiece influences on the closing of the defects. The concave faces with angle of 150° and it relative depth (d/D) equal to 0.25; 0.20 and 0.15 have been used in investigation. This technique has been described in detail in paragraph 4.1.

The degree of the hole closing after upsetting of the profiled workpieces with concave faces to 50% is shown in Fig. 2. According to the modelling results, it has been determined that for investigated parameters of the faces depth the hole closing in the middle zone appears. The degree of the hole closing for specimens with relative depth of the faces was 0.15 maximum. The

specimens profiled to the depth of 0.25 from workpiece's diameter have been shown the worse results of axial defects closing.

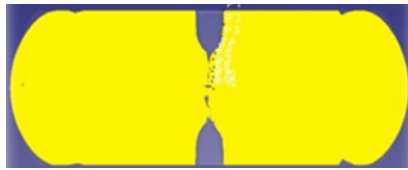

Figure 2. Hole closing after upsetting on 50% profiled workpieces with concave faces: a – $d/D=25\%$; b – $d/D=15\%$

A dependence of the hole closing during upsetting of the four-beam workpieces with different relative height of the concave faces is shown in Fig.3. The analysis of obtained results allowed to found that relative depth of the concave faces more than 0.15 did not lead to increasing of the defects closing.

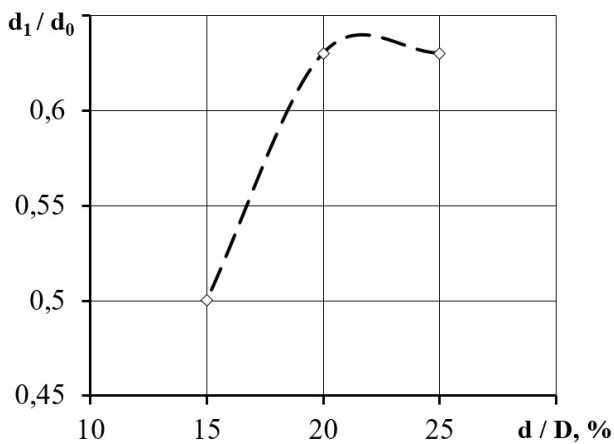

Figure 3. Changing relative diameter of the hole during upsetting of the four-beam workpieces with different relative height of the concave faces

It was established that after upsetting with height reduction of 50% of the workpieces with relative depth of $d/D=0.15$ the closing of the defect's diameter occurred on 50% (Fig. 3).

4.2 Stress-strain state of the four-beam workpieces during upsetting operation

The strain distribution in the workpiece's meridional cross-section after upsetting 50% is shown in Fig. 4. The maximum strains are localized into forging's central part. The minimal strains is on the workpiece's faces. The distribution of strain for different values of the workpiece's concave faces have a similar result. An area of the strain with maximum values is more than 35...45% for the upsetting of the four-beam workpieces with depth of the concave faces $d/D = 0.15$ compare with other ratio of geometrical parameters (Fig. 4).

The upsetting of the four-beam workpieces changes a forging's stress state (Fig. 5). A mean stress with sign "minus" into central forging's zone appears. It leads to the compressive stresses with value of 85 MPa in the axial zone for the concave faces $d/D = 0.15$ (Fig. 5).

Decreasing of the ratio depth of the four-beam workpieces leads to changing of the mean-stress distribution into workpiece's volume. The concave faces with maximum depth increase an area and value of the compressive

stresses. The upsetting of the four-beam workpieces does not exclude a formation of shape-barrel lateral surface with appearing a tensile stress in this place.

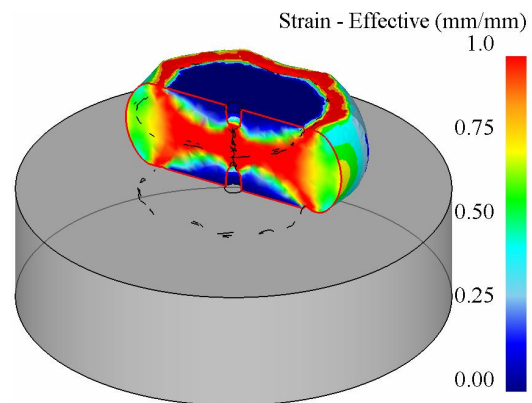

Figure 4. Strain distribution during upsetting operation of the four-beam workpieces ($d/D = 0.15$)

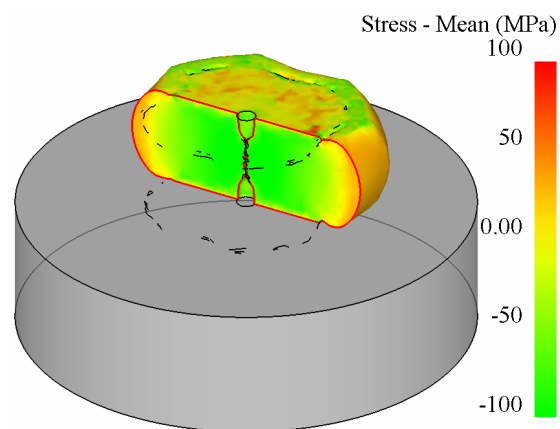

Figure 5. Mean stress during upsetting operation of the four-beam workpieces ($d/D = 0.15$)

The concave faces influence the hydrostatic stress that appears in workpiece during upsetting. The concave faces of the four-beam workpiece can increase the level of a compression stresses. The value of the compression stress can be evaluated by the parameter of the stress state ($\Pi\sigma$). The parameter of the stress state ($\Pi\sigma$) with sign "minus" shows that into the workpiece's body appears the compressive stress (Fig. 6). This state will contribute to closing of the internal defects of an ingot.

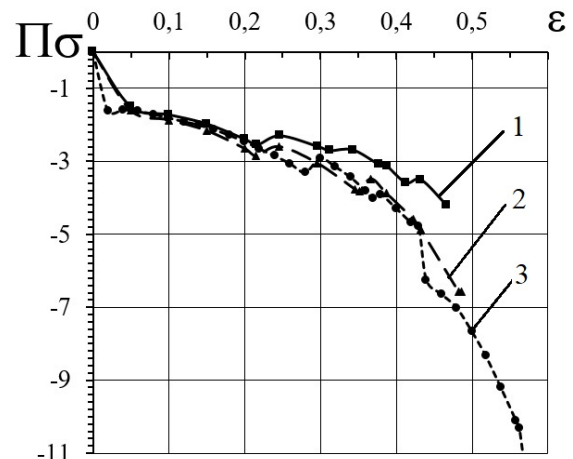

Figure 6. The parameter of the stress state during upsetting of the workpieces with concave faces: 1 – $d/D = 0.25$; 2 – $d/D = 0.20$; 3 – $d/D = 0.15$

The level of the compression stress during workpieces upsetting with concave faces is increased (Fig. 6). The analysis of obtained results allowed to establish that with a relative depth of the faces of 15% the maximum compressive stresses arise after deformation by 50% ($\Pi\sigma = -11$). The minimal value the parameter of the stress state ($\Pi\sigma = -4.2$) corresponds to the depth of the concave faces $d/D = 0.25$ and degree of upsetting $\varepsilon = 0.46$. This stress state does not lead to complete closing of the axial defects.

5. EXPERIMENTAL INVESTIGATIONS

5.1 The closing of the axial defects after workpieces upsetting with the concave faces

Investigations of the defects closing during workpieces upsetting with concave faces have been verified by experiments on steel specimens at hot deformation. A heating of the steel specimen has been conducted to temperature of 1150°C with further it drawing to four-beam cross-section by convex dies with angle of the wedge of 150° and degree of a reduction of 20% and canting of 90° (Fig. 7, a). The upsetting operation has been realized after additional heating. Templates have been cooled and cut in the place where the axial defect was located (Fig. 7, b).

Based on analysis of a macrostructure investigation, it has been determined that during upsetting operation of the profiled workpiece to the four-beam cross-section with angle of the concave faces of 150° the complete closing of the axial defect has not occurred (Fig. 7, b).



a

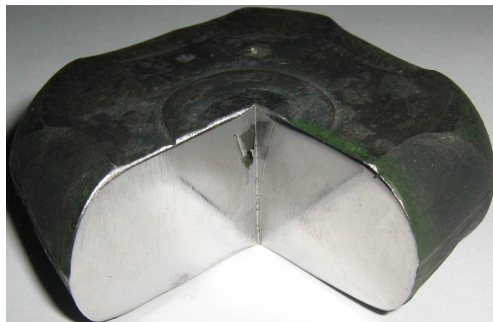

b

Figure 7. Experimental investigation on the steel specimens: a – profiling billet to the four-beam cross-section; b – shape of the axial defect after upsetting of the profiled workpiece

5.2 An approbation of the four-beam workpieces upsetting

There have been made 22 forgings of backup rolls according to the developed technological forging process of profiling on a four-beam billet and its further upsetting. The degree of the reduction during profiling by convex dies was 20% from the workpiece's diameter (Fig. 8). This reduction degree has been determined based on results of the theoretical and experimental investigations. The workpiece after profiling to the concave cross-section has been upsetted (Fig. 8).

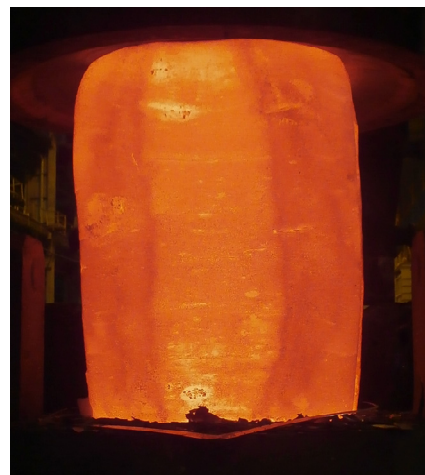

Figure 8. Approbation a new process forging of the workpiece with weight 57.7 ton (upsetting process)

Ledges formation of the backup rolls after upsetting have been carry out by traditional forging operations.



Figure 9. Forged workpiece

The ultrasonic test for verification of the internal defects after heat and mechanical treatments of the part has been carried out (Fig. 9).

6. DISCUSSION OF OBTAINED RESULTS OF THE PROFILED WORKPIECE UPSETTING

The new method upsetting of the four-beam workpieces with angle of the concave faces equal to 150° and different it depth has been investigated. SSS of the workpiece and dependence changing of the defects dimensions during upsetting according to the research results have been determined. The analysis of obtained results allowed to found an effective recommendations of the upsetting process and it advantages over existing method of deformation:

- the maximum closing of the hole occurs after upsetting on 65 % for workpiece with relative depth of the concave faces of 15-20% from workpiece's diameter;
- the concave faces with value of 15% from workpiece's diameter lead to appearance into workpiece's body the compression stresses after upsetting on 55%. This fact is confirmed by parameter of the stress state with level of 10...– 11.

Moreover, the maximum deformations appear in the axial zone of the four-beam workpiece for the specify parameters. This will help to closing of the internal defects additionally. An increasing of the level deformation during upsetting of the four-beam workpieces leads to increasing of the compression stresses into workpiece's body.

The obtained results for reshaping and UST have been checked and compared with correspond traditional technological processes of the forging such workpieces. The analysis of results of the UST for forgings manufactured with using new method of upsetting allows to conclude that obtained forgings correspond to requirement of standard SEP 1921. The obtained results confirm a positive influence of the concave faces of the profiled workpiece to increasing the level of the compression stresses in the axial zone and welding of the internal defects during forging.

Manufactured forgings correspond to requirements of a customer. The obtained results confirm the theoretical data of the investigations establishing with using of FEM and experiment.

The disadvantages of developed upsetting method of the workpieces with concave faces are:

- degree increasing of the concave faces depth lead to decrease the level of the compression stresses into workpiece;
- the developed method of the upsetting does not eliminate a formation of a convex lateral surface, which can lead to cracks.

Novelty:

- the new process of upsetting massive workpieces has been further developed;
- the dependencies of changing dimensions and SSS during upsetting process of the four-beam workpieces have been established. These dependencies allowed to determine the effective geometrical parameters of such workpieces.

The practical aspect of using the research result is improvement of the forging process of massive workpieces. The proposed approach to increasing density of an internal structure based on using upsetting of the four-beam workpieces with angle of the concave faces equal to 150° is an actually. The obtained results lead to quantitative change of the workpiece's SSS. As a result, the level of the compression stresses into workpiece's body has been increased. It has been provided a more intensive welding of the axial defects.

However, a complex influence of the operations profiling and upsetting to the SSS and welding level of the internal defects has not been investigated in the work. Therefore, the further research need to direct on determining of the complex influence such operations as profiling and upsetting of the four-beam workpieces for establishing the closing level of the internal defects.

7. CONCLUSIONS

The angle influence of the concave faces 150° to the strain distribution, stresses and welding of the internal defects after upsetting has been determined. The closing of the defect takes place after upsetting of more than 10%. The maximum closing of the defect takes place after upsetting 65%. The concave faces with depth 15% from workpiece's diameter after upsetting 55% lead to appearance of the compression stresses in –10...–11 times more of a stress effective.

The new science-based upsetting method of the four-beam workpieces increasing the quality of the massive parts has been developed.

The recommendations for design of the forging processes with using new schemes deformation have been developed based on conducted theoretical and experimental investigations.

The approbation and implementation of proposed method of the forging in the manufacturing conditions have been realized. The quality of the forgings based on results of the UST has been increased by means of absence of the internal defects exceeding the requirements of the standard SEP 1921.

REFERENCES

- [1] Markov, O. E., Gerasimenko, O. V., Shapoval, A. A., Abdulov, O. R., Zhytnikov, R. U.: Computerized simulation of shortened ingots with a controlled crystallization for manufacturing of high-quality forgings, *The Int. J. of Advanced Manufacturing Technology*, Vol. 103, pp. 3057-3065, 2019, doi: <http://doi.org/10.1007/s00170-019-03749-4>
- [2] Smyrnov, Y. N., Skliar, V. A., Belevitin, V. A., Shmyglya, R. A., Smyrnov, O. Y.: Defect healing in the axial zone of continuous-cast billet, *Steel in Translation*, Vol. 46, No. 5, pp. 325-328, 2016, <http://dx.doi.org/10.3103/S0967091216050132>
- [3] Wang, J., Fu, P., Liu, H., Li, D., Li, Y.: Shrinkage porosity criteria and optimized design of a 100-ton 30Cr2Ni4MoV forging ingot, *Mater. Design*, Vol. 35, pp. 446-456, 2012, <http://dx.doi.org/10.1016/j.matdes.2011.09.056>
- [4] Zhang, X-X. et al.: A criterion for void closure in large ingots during hot forging, *J. Mater. Process. Tech.*, Vol. 209, No. 4, pp. 1950-1959, 2009, <http://dx.doi.org/10.1016/j.jmatprotec.2008.04.051>
- [5] Dobrzański, L. A., Grajcar, A., Borek, W.: Influence of hot-working conditions on a structure of high-manganese austenitic steels, *Journal of Achievements in Materials and Manufacturing Engineering*, Vol. 29, No. 2, pp. 139–142, 2008.
- [6] Hrudkina, N.S., Aliieva, L.I.: Modeling of cold extrusion processes using kinematic trapezoidal modules, *FME Transactions*, Vol. 48, No 2, pp. 357-363, 2020, doi:10.5937/fme2002357H.
- [7] Ameli, A., Movahhedy, M.R.: A parametric study on residual stresses and forging load in cold radial forging process, *Int. J. Adv. Manuf. Tech.*, Vol. 33 No. 1–2, pp. 7-17, 2007, <http://dx.doi.org/10.1007/s00170-006-0453-2>

- [8] Regodić, M. M., Šiniković, G. B., Veg, E. A., Jeli, Z. V., Gubelj, N.: Application of "Omega" Deformer for Stress Measuring in Dynamic Loading of the Structure, FME Transactions, Vol. 46, No. 4, pp. 520-524, 2018. doi:10.5937/fmet180 4520R. www.scopus.com.
- [9] Markov, O.E., Oleshko, M.V., Mishina, V.I.: Development of Energy-saving Technological Process of Shafts Forging Weighting More Than 100 Tons without Ingot Upsetting, Metalurgical and Mining Industry, Vol. 3, No. 7, pp. 87-90, 2011, http://www.metaljournal.com.ua/assets/Uploads/attachments/87Markov.pdf
- [10] Markov, O.E., Perig, A.V., Markova, M.A. and Zlygoriev, V.N.: Development of a new process for forging plates using intensive plastic deformation, Int. J. Adv. Manuf. Technol., Vol. 83, No. 9-12, pp. 2159-2174, 2016, http://doi.org/10.1007/s00170-015-8217-5
- [11] Saby, M., Bouchard, P.-O., Bernacki, M.: A geometry-dependent model for void closure in hot metal forming, Finite Elements in Analysis and Design, Vol. 105, pp. 63-78, 2015, http://dx.doi.org/10.1016/j.finel.2015.07.003
- [12] Markov, O.E.: Forging of Large Pieces by Tapered Faces, Steel in Translation, Vol. 42, No. 12, pp. 808-810, 2012, https://doi.org/10.3103/S0967091212120054
- [13] Dudra, S. P. and Im, Y. T.: Analysis of void closure in open-die forging, J. Mach. Tools Manuf., Vol. 30, pp. 65-75, 1990, https://doi:10.1016/0890-6955(90)90042-H
- [14] Chen, K., Yang, Y., Shao, G. and Liu, K.: Strain function analysis method for void closure in the forging process of large sized steel ingot, Computational Materials Science, Vol. 51, No. 1, pp. 72-77, 2012, http://dx.doi.org/10.1016/j.commatsci.2011.07.011
- [15] Markov, O., Kosilov, M., Panov, V., Kukhar, V., Karnaukh, S., Ragulina, N., Bochanov P., Rizak P.: Modeling and improvement of saddling a stepped hollow workpiece with a profiled tool, Eastern-European Journal of Enterprise Technologies, Vol. 6/1, No. 102, pp.19-25, 2019, DOI: https://doi.org/10.15587/1729-4061.2019.183663
- [16] Nakasaki, M., Takasu, I., Utsunomiya, H.: Application of hydrostatic integration parameter for free-forging and rolling, J. Mater. Process. Technol., Vol. 177, pp. 521-524, 2006, https://doi:10.1016/j.jmatprotec.2006.04.102
- [17] Markov, O.E., Perig, A.V., Zlygoriev, V.N., Markova, M.A. and Grin, A.G.: A new process for forging shafts with convex dies. Research into the stressed state, Int. J. Adv. Manuf. Technol., Vol. 90, pp. 801-818, 2017, http://doi.org/10.1007/s00170-016-9378-6
- [18] Chen, M-S. and Lin, Y.C.: Numerical simulation and experimental verification of void evolution inside large forgings during hot working, Int. J. of Plasticity, Vol. 49, pp. 53-70, 2013, http://dx.doi.org/10.1016/j.ijplas.2013.02.017
- [19] Markov, O.E., Perig, A.V., Zlygoriev, V.N., Markova, M.A. and Kosilov, M.S.: Development of forging processes using intermediate workpiece profiling before drawing: research into strained state, J. Braz. Soc. Mech. Sci. Eng., Vol. 39, No. 4, pp. 4649-4665, 2017, https://doi.org/10.1007/S40430-017-0812-Y
- [20] Delošević, M., Petrović, D., Bižić, M.: Identification of the Stress-Strain State of a Cylindrical Tank with Walls of Variable Thickness, FME Transactions, Vol. 39, No. 1, pp. 25-32, 2011.
- [21] Aksakal, B., Osman, F. H., Bramley A. N.: Determination of experimental axial and sideways metal flow in open die forging, Material and Design, Vol. 3, pp. 576-583, 2008.
- [22] Christiansen, P., Martins, P. A. F., Bay, N., Hattel, J.H.: Multi-objective optimization of die geometry in ingot forging, Proceeding 11th International Conference on Technology of Plasticity, ICTP, 19-24. 10.2014, Nagoya Congress Center, Nagoya, Japan, Procedia Engineering. Vol. 81, pp. 2457-2462, 2014, https://doi:10.1016/j.proeng.2014.10.350
- [23] Cho, J. R., Bae, W.B., Kim, Y.H., Choi, S.S. and Kim, D. K.: Analysis of the cogging process for heavy ingots by finite element method and physical modeling method, J. Mater. Process. Technol., Vol. 80-81, pp. 161-165, 1998.
- [24] Kakimoto, H., Arikawa, T., Takahashi, Y., Tanaka, T. and Imaida, Y.: Development of forging process design to close internal voids, J. Mater. Process. Tech., Vol. 210 No. 3, pp. 415-422, 2010, http://dx.doi.org/10.1016/j.jmatprotec.2009.09.022
- [25] Kun, C., Yitao, Y., Guangjie, S. and Kejia, L.: Strain function analysis method for void closure in the forging process of large sized steel ingot, Computational Materials Science, Vol. 51, No. 1, pp. 72-77, 2012, http://dx.doi.org/10.1016/j.commatsci.2011.07.011
- [26] Zhang, S.H., Wang, Z.R., Wang, Z.T., Xu, Y. and Chen, K.B.: Some new features in the development of metal forming technology, J. Materials Processing Technology, Vol. 151, No. 1-3, pp. 39-47, 2004, doi:10.1016/j.jmatprotec.2004.04.098.
- [27] Markov O, Zlygoriev V, Gerasimenko O, Hrudkina N and Shevtsov S: Improving the quality of forgings based on upsetting the workpieces with concave facets, Eastern-European Journal of Enterprise Technologies, Vol. 5/1, No. 95, pp. 16-24, 2018, http://doi.org/10.15587/1729-4061.2018.142674

NOMENCLATURE

S_{ij}	components of a deviator's stress, [mpa]
$\dot{\epsilon}_{ij}$	components of strain rates, [1/s]
σ_{ij}	components of tensor stresses, [mpa]
$\bar{\epsilon}$	strain, []

$\dot{\varepsilon}$	strain rate, [1/s]
T	temperature, [°C]
$P\sigma$	parameter of the stress state, []
σ_0	hydrostatic stress, [MPa]
σ_i	stress effective, [MPa]

Abbreviations

SSS	stress-strain state
UST	ultrasonic test
FEM	Finite Element Method

УНАПРЕЂЕЊЕ ПРОЦЕСА САБИЈАЊА КОД ЧЕТВОРОКРАКИХ ОБРАДАКА БАЗИРАНО НА КОМПЈУТЕРСКОМ И ФИЗИЧКОМ МОДЕЛИРАЊУ

**О.Е. Марков, В.В. Кукхар, В. Злигориев, А.А.
Шаповал, А.С. Квашчински, Р.У. Житников**

Истражује се метод сабијања код великих ингота. Предложени метод се састоји од профилисаних обрадака са конкавним странама. Угао конкавне површине износи 150° а релативна дубина се креће од 15% - 25% пречника обратка. Ефективна деформација и просечни напон у подужном попречном пресеку одређени су после сабијања коришћењем МКЕ методе. Вредности сабојног напона су одређене на основу параметра стања напона. Метода МКЕ је омогућила одређивање рационалне дубине конкавних површина, која би требало да износи 15% пречника обратка. Максимално затварања унутрашњих дефеката се врши услед дубине конкавних површина. Резултати су проверени експерименталним истраживањима. Утврђено је да сабијање код четворокраких обрадака побољшава квалитет великих делова.