

Developing a Reciprocating Mechanism for the Emergency Implementation of a Mechanical Pulmonary Ventilator using an Integrated CAD-MBD Procedure

Carmine M. Pappalardo

Tenure-Track Assistant Professor
University of Salerno
Department of Industrial Engineering
Italy

Angelo Vece

Researcher
University of Salerno
Spin-Off MEID4
Italy

Davide Galdi

Researcher
University of Salerno
Spin-Off MEID4
Italy

Domenico Guida

Full Professor
University of Salerno
Department of Industrial Engineering
Italy

Following the COVID-19 outbreak, the redesign of an emergency mechanical pulmonary ventilator that is cheap and easily portable became necessary in several contexts, such as emergency hotspots and environments with poor resources. To address this important issue, a general multibody approach is employed in this paper to develop a reciprocating mechanism suitable for retrofitting the existing manual mechanical ventilators through computer-aided engineering tools. By analyzing various basic articulated mechanisms typically found in engineering mechanics, a prototype is created and reproduced in a three-dimensional environment using SOLIDWORKS's CAD software. Subsequently, a high-fidelity mechanical model is developed starting from the CAD geometry and employing the SIMSCAPE MULTIBODY software, an extension of the MATLAB family of programs that can effectively and efficiently perform kinematic and dynamic simulations of the mechanism of interest. As discussed in the paper, by carrying out numerous numerical experiments, the virtual simulations predict several fundamental medical parameters, such as the airflow introduced into patients, the respiratory rate, and the respiratory ratio.

Keywords: COVID-19, Mechanical Pulmonary Ventilator, Multibody System Dynamics, Kinematic Synthesis, Integration of Computer-Aided Design and Analysis (I-CAD-A).

1. INTRODUCTION

1.1 Background Information and Research Significance

The main topics of interest for the authors' research are multibody system dynamics, nonlinear control of articulated machines and mechanisms, and applied system and parameter identification. This paper fits this research framework since it focuses on the computer-aided engineering analysis and design of a reciprocating mechanism for retrofitting the existing mechanical ventilators that are actioned by hand by the medical operators during the respiratory crisis of the patients occurred during the outbreak of the COVID-19 pandemic disease.

In general, the benefits of virtual modeling and computer simulations are multiple. These include the ability to test various conditions that could damage the equipment or the personnel, the ability to test systems where no physical prototypes exist, and the capacity to test twenty-four hours a day. This is particularly important in the case of articulated mechanical systems modeled as multibody systems [1,2]. Multibody systems

are articulated mechanical systems composed of four fundamental items: rigid and/or flexible bodies, kinematic joints modeled as holonomic and/or nonholonomic constraints, external/internal force elements, and external/internal force fields. Furthermore, virtual prototyping implies the possibility of reducing costs and errors during the design process [3-6]. In particular, through the use of virtual modeling tools and computer simulations, the main purpose of this research is to design a machine capable of solving the problem of reconstructing a pulmonary mechanical ventilator. Employing an approach devoted to the Integration of Computer-Aided Design and Analysis (I-CAD-A) is done using the software SOLIDWORKS and SIMSCAPE MULTIBODY [7,8]. The use of this software led to the definition of a virtual prototype, capable of reproducing the behavior of the system of interest for the present analysis without operating on the actual physical system.

1.2 Formulation of the problem of interest for this investigation

The COVID-19 pandemic, which the World Health Organization (WHO) has declared a public health emergency of international concern, has shown worldwide many of the structural difficulties of the healthcare system [9]. In particular, among all the issues inherent to the pandemic, the need for mechanical ventilatory

Received: July 2021, Accepted: March 2022

Correspondence to: Carmine Maria Pappalardo
Department of Industrial Engineering, Via Giovanni
Paolo II, 132, 84084, Fisciano (Salerno), Italy
E-mail: cpappalardo@unisa.it

doi:10.5937/fme2201238P

© Faculty of Mechanical Engineering, Belgrade. All rights reserved

FME Transactions (2022) 50, 238-247 238

support reached its peak during the pandemic period since COVID-19 patients mainly were treated with mechanical ventilation [10]. Currently, however, due to their excessively high cost for countries with few resources and their fragility and vulnerability in continued use, the highly sophisticated ventilators found in the major hospitals worldwide are unable to cope with the pandemic difficulties [11]. To try to address this important problem, several academic and research institutions specifically decided to propose the design of an inexpensive, manually operated fan starting from a few simple mechanisms [12]. In other words, for this series of reasons, many research groups in western universities decided to create mechanical ventilation systems, which certainly will not have the performance of sophisticated fans but which are the most economical, standardized, and available to everyone. This issue represents this investigation's main problem of interest and its principal research question.

1.3 Literature review

Given the international scope of the pandemic, research and development of a mechanical pulmonary ventilator model invested most of the universities in the world. More importantly, the problem of pulmonary mechanical ventilation is also related to other pulmonary infections that differ from the COVID-19 disease. This important issue generated a worldwide research effort that spans from the Massachusetts Institute of Technology (MIT) in Cambridge, and Rice University in Houston, to the University of Bicocca in Milan and some universities in Brazil. For instance, to solve this issue, Shahid proposed the prototype of a low-cost ventilator based on the mechanical compression of the AMBU (Artificial Manual Breathing Unit) bag since not every medical facility can afford a ventilator due to financial restrictions [13]. Also, MIT developed a pulmonary fan model that simulates the hand movement compressing the AMBU balloon with a forceps-like mechanism. In particular, Kwon et al. manufactured a ventilator prototype that is scalable for mass production and demonstrated its basic clinical feasibility by ventilating a pig as a proof of concept [14].

On the other hand, Rice University devised a mechanical fan model called ApolloBVM, which is based on a rack-and-pinion mechanism that compresses the AMBU balloon from both sides. Indeed, Tsuzuki et al. recognized the importance of mechanical ventilation since this means is crucial for patient recovery in Brazil and proposed an original solution to economically develop such a device using commercial off-the-shelf components [15]. In Italy, Bicocca University has designed a fully electronic pulmonary fan model, with the complexity of the device managed by an electronic control unit responsible for controlling and setting the breathing parameters. More specifically, Abba et al. developed a new prototype of a mechanical ventilator in intensive therapy designed for rapid, large-scale, low-cost production [16]. Due to their prevalence, severity, extent trends, and economic impact [17-20]. Therefore, several other university research projects focused on these important topics can be found in the literature and

consulting the Internet. In this vein, the authors' research group at the Engineering Mechanics Laboratory, collocated at the Department of Industrial Engineering of the University of Salerno, raised the challenge. Thus, a new design solution for a simple and effective device is proposed in this work, and its medical performance is analyzed in terms of mechanical pulmonary ventilation.

1.4 Scope and contribution of this study

In this paper, a virtual prototype of a mechanical ventilator is developed, and its dynamical performance is evaluated through numerical experiments. The main goal of the virtual model of the mechanical system devised in this work is to assist patients affected by the COVID-19 disease [3-6]. For this purpose, a quick return mechanism is assumed as the fundamental mechanical scheme for the mechanical system of interest. Furthermore, an integrated CAD-MBD procedure is used for obtaining a viable prototype of the mechanical ventilator, whose geometric model is constructed with the SOLIDWORKS software and is subsequently simulated in a dynamic environment with the SIMSCAPE MULTIBODY software. More specifically, the prototype of the pulmonary mechanical ventilator proposed in this investigation is based on the compression of the AMBU balloon to introduce air into the patient by replacing the hand manual movement performed by the human operator [21,22]. This solution is particularly suitable for emergency situations. In fact, in the event of a malfunction of the mechanism, or the absence of electrical power, it is always possible to detach the AMBU balloon from the seat where it is anchored and use it manually. Therefore, in the design process performed in this work, a specific feature required for the ventilator is its optimal response to different realistic scenarios. This fundamental objective is achieved in the proposed design by controlling the typical parameters of respiration, i.e., respiration rate, volume to be insufflated to the patient, and inhalation-exhalation ratio indicated as I:E [23,24]. More importantly, during the computer-aided design of the virtual prototype carried out in this paper, these vital parameters are intentionally related to the geometric parameters of the mechanism under consideration, i.e., the engine rotation speed and the piston stroke [25]. To try to address the problems mentioned above and provide a solution for these important challenges, the performance of the virtual prototype of the mechanical ventilator developed in this paper is assessed through the use of several computer simulations based on the interaction of the CAD model devised using SOLIDWORKS with the MBD model developed employing SIMSCAPE MULTIBODY.

1.5 Organization of the manuscript

This manuscript is organized as follows. Section 2 provides an overview of the fundamental aspects of the kinematics and dynamics of multibody mechanical systems. In Section 3, the mechanical system based on the quick return mechanism proposed in this paper for

constructing a mechanical pulmonary ventilator is described. This section shows the CAD and MBD models of the mechanical pulmonary ventilator constructed by the quick return mechanism and the main results achieved in this work. In Section 4, some general conclusions, a summary of the work done, and the possibility of future developments of the proposed mechanical system are reported.

2. KINEMATIC AND DYNAMIC ANALYSIS OF MULTIBODY SYSTEMS

2.1 Kinematics

From a general perspective [1,2], the kinematic features of a rigid body can be modeled using the following fundamental equation:

$$\mathbf{r} = \mathbf{R} + \mathbf{A}\bar{\mathbf{u}} \quad (1)$$

where \mathbf{r} is the global position vector of a generic point P collocated on the rigid body of interest, \mathbf{R} represents the global position vector of the reference point of the rigid body, \mathbf{A} denotes the rotation matrix necessary for transforming the local position coordinates into the global position coordinates, and $\bar{\mathbf{u}}$ identifies the local position vector of a generic point P . Considering this basic equation, known as the fundamental formula of rigid kinematics, one can obtain the global velocity vector and the global acceleration vector of a generic material point on the rigid body by performing a time derivation process. To this end, one can write:

$$\dot{\mathbf{r}} = \dot{\mathbf{R}} + \mathbf{A}(\bar{\boldsymbol{\omega}} \times \bar{\mathbf{u}}) \quad (2)$$

and

$$\ddot{\mathbf{r}} = \ddot{\mathbf{R}} + \mathbf{A}(\bar{\boldsymbol{\alpha}} \times \bar{\mathbf{u}}) + \mathbf{A}(\bar{\boldsymbol{\omega}} \times (\bar{\boldsymbol{\omega}} \times \bar{\mathbf{u}})) \quad (3)$$

where $\dot{\mathbf{r}}$ is the global velocity vector of the generic point, $\dot{\mathbf{R}}$ denotes the global velocity vector of the reference point of the rigid body, $\bar{\boldsymbol{\omega}}$ represents the local angular velocity vector of the rigid body, $\ddot{\mathbf{r}}$ is the global acceleration vector of the material point, $\ddot{\mathbf{R}}$ is the global acceleration vector of the reference point of the rigid body, and $\bar{\boldsymbol{\alpha}}$ identifies the local angular acceleration vector of the rigid body. This general formulation completes the kinematic description of the motion of a particle on a rigid body in a three-dimensional space.

2.2 Dynamics

To perform the dynamic analysis of a multibody system, that is, an articulated mechanical system composed of rigid bodies, kinematic joints, force elements, and force fields, the first step is to define a vector of generalized coordinates denoted with \mathbf{q} . In the case of the use of a redundant coordinate formulation, because of the presence of n_c algebraic constraints modeling the mechanical joints, the dimension of the configuration vector \mathbf{q} denoted with n_q is larger than the number of degrees of freedom of the mechanical system denoted with n_f . Once the kinematics of the system of interest is known in terms of the geometric quantities embedded in the generalized coordinate vector \mathbf{q} , the system equations of motion can be readily obtained by using

the Lagrange equations of the first kind. These fundamental equations are given by:

$$\begin{aligned} \frac{d}{dt} \left(\frac{\partial T}{\partial \dot{\mathbf{q}}} \right)^T - \left(\frac{\partial T}{\partial \mathbf{q}} \right)^T + \left(\frac{\partial V}{\partial \mathbf{q}} \right)^T \\ + \left(\frac{\partial U}{\partial \mathbf{q}} \right)^T + \left(\frac{\partial \mathbf{C}}{\partial \mathbf{q}} \right)^T \boldsymbol{\lambda} = \mathbf{Q}_{e,nc}^* \end{aligned} \quad (4)$$

In the Lagrange equations of the first kind, T represents the system kinetic energy, U represents the system potential energy, V represents the system Rayleigh dissipation function, \mathbf{C} represents the complete vector of algebraic equations that mathematically describes the kinematic joints, $\boldsymbol{\lambda}$ represents the vector of Lagrange multipliers associated with the algebraic equations, and $\mathbf{Q}_{e,nc}^*$ represents the generalized force vector associated with the non-conservative external forces acting on the multibody mechanical system. The implementation of the Lagrange equations of the first kind leads to the following set of equations of motion derived by using a redundant coordinate formulation:

$$\begin{cases} \mathbf{M}\ddot{\mathbf{q}} + \mathbf{C}_q^T \boldsymbol{\lambda} = \mathbf{Q}_v + \mathbf{Q}_e \\ \mathbf{C} = \mathbf{0} \end{cases} \quad (5)$$

In the differential-algebraic set of the equations of motion given above, \mathbf{M} is the system mass matrix having dimensions $n_q \times n_q$, \mathbf{C}_q is the constraint Jacobian matrix having dimensions $n_c \times n_q$, \mathbf{Q}_v is the inertia quadratic velocity vector of dimension n_q that includes the inertial terms that are quadratic in the generalized velocities, and \mathbf{Q}_e is the total generalized force vector of dimension n_q associated with the external forces. For well-posed problems, the system mass matrix \mathbf{M} is invertible, namely, it is a non-singular matrix. Consequently, by using a proper multibody solution procedure at each instant of time, one can derive the generalized acceleration vector denoted with $\ddot{\mathbf{q}}$, which is required in the computer implementation and in the numerical solution of the equations of motion. This computation can be performed by replacing the vector of constraint equations that appears in the equations of motion with its second derivative taken with respect to time as follows:

$$\begin{cases} \mathbf{M}\ddot{\mathbf{q}} + \mathbf{C}_q^T \boldsymbol{\lambda} = \mathbf{Q}_v + \mathbf{Q}_e \\ \mathbf{C}_q \ddot{\mathbf{q}} = \mathbf{Q}_d \end{cases} \quad (6)$$

where \mathbf{Q}_d is the constraint quadratic velocity vector of dimension n_c that includes the algebraic terms that are quadratic in the generalized velocities arising from the second time derivative of the kinematic constraints. To compute the system generalized acceleration vector, one can readily employ the matrix method called augmented formulation that is given by:

$$\begin{bmatrix} \mathbf{M} & \mathbf{C}_q^T \\ \mathbf{C}_q & \mathbf{0} \end{bmatrix} \begin{bmatrix} \ddot{\mathbf{q}} \\ \boldsymbol{\lambda} \end{bmatrix} = \begin{bmatrix} \mathbf{Q}_v + \mathbf{Q}_e \\ \mathbf{Q}_d \end{bmatrix} \quad (7)$$

Thus, the formulation of the equations of motion based on the multibody approach allows for the use of standard numerical schemes developed for Ordinary Differential Equations (ODEs), in conjunction with a proper constraint stabilization procedure, which is always needed in the case of the use of a non-minimal coordinate formulation approach [1,2]. Therefore, considering a generic mechanical system composed of several rigid bodies connected by kinematic pairs, the dynamic behavior of the multibody system is described by the differential-algebraic equations of motion, which can be systematically assembled employing the multibody approach and solved using standard numerical integration subroutines.

3. NUMERICAL RESULTS AND DISCUSSION

3.1 Description of the Virtual Prototype

The virtual prototype of the emergency mechanical ventilator developed in this work is based on the quick return mechanism and is shown in Figure 1.

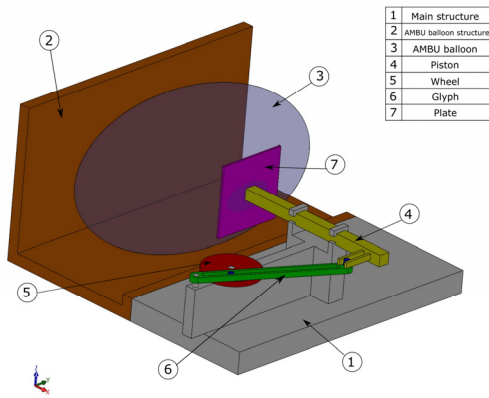

Figure 1. Virtual prototype of the emergency mechanical ventilator

In Figure 1, body 1 is the main structure of the mechanical system, body 2 is the AMBU balloon support structure, body 3 is the AMBU balloon, body 4 is the mechanical piston, body 5 is the wheel that works as the crank of the mechanism, body 6 is the oscillating glyph, and body 7 is the actuator plate. A schematic representation of the quick return mechanism is shown in Figure 2. In analogy with the slider-crank mechanism, this is a mechanism that transforms the uniform rotary motion of the shaft into an alternating rectilinear motion of the piston. However, in the quick return mechanism, when the crank rotates counter-clockwise, the motion of the piston is characterized by a forward stroke that occurs more slowly than the return stroke. The quick return mechanism is formed by a wheel on which there is a pin that slides inside a slot of a glyph and makes it oscillate. The glyph has a hinged end, while on the opposite end of the glyph, there is another pin that slides inside the guide of the piston. Due to the presence of a prismatic pair, the piston performs a horizontal linear movement. In this work, the alternative motion of the piston is exploited in the virtual design of the emergency mechanical ventilator to compress the AMBU bag. In the quick return mechanism, the ratio between the times of the forward and return strokes

depends only on the geometry of the system. In particular, this parameter depends on the ratio of the angles θ_1 and θ_2 shown in Figure 2.

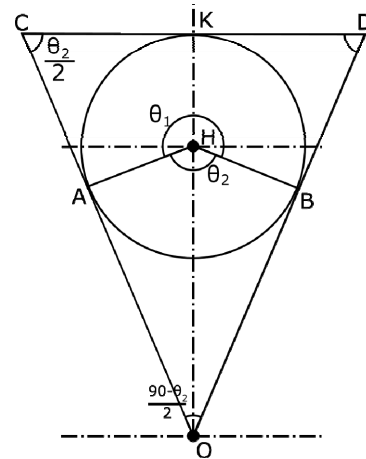

Figure 2. Geometric representation of the quick return mechanism

In order to have a time ratio equal to $R = 2$, as in the case study considered in this work, we have:

$$\begin{cases} \theta_1 = 2 \\ \theta_2 = 2 \\ \theta_1 + \theta_2 = 360^\circ \end{cases} \Rightarrow \begin{cases} \theta_1 = 240^\circ \\ \theta_2 = 120^\circ \end{cases} \quad (8)$$

Considering the numerical values of the characteristic angles mentioned above, and taking advantage of the similarity of the triangles shown in Figure 2, by setting $\overline{AH} = D/2$ (radius of the wheel) and $\overline{OC} = L$ (length of the glyph), one can write:

$$\frac{\overline{OH}}{\overline{AH}} = \frac{\overline{CO}}{\overline{OH}} = \frac{\frac{D}{2}}{\cos(\frac{\theta_2}{2})} = \frac{D}{\cos(60^\circ)} = D \quad (9)$$

and

$$\frac{\overline{CK}}{\overline{AH}} = \frac{\overline{CO}}{\overline{OH}} \Rightarrow \overline{CK} = \frac{DL}{2D} = \frac{L}{2} \quad (10)$$

At this point, it is necessary to assign a value to the geometric quantities D and L introduced previously. To do this, it is necessary to know the dimensions of the AMBU balloon. Considering the standard specifications of the AMBU balloon for an adult patient having a length equal to 295 (mm) and a diameter equal to 127 (mm), the AMBU balloon is approximated as a spheroid having a thickness equal to 1.5 (mm) with a semi-minor axis of 63.5 (mm) and a semi-major axis of 147.5 (mm). By indicating the angular position of the crank with θ , evaluated in this case counter clockwise from the positive direction of the vertical axis, the AMBU balloon is then positioned so that it is in contact with the plate in the Lower Dead Center (LDC) corresponding to $\theta = 4\pi/3 = 240^\circ$. This is done to not have passive phases during the displacement of the piston and, more importantly, so as to start the compression phase, and therefore the patient inhalation phase, at the same instant of the outward stroke of the piston. When the

Top Dead Center (TDC) is reached for $\theta = 2\pi/3 = 120^\circ$, that is, when the piston starts the return stroke, at the same moment there is the maximum compression of the AMBU balloon and the beginning of the exhalation phase. This is the reason why the stroke of the piston \overline{CD} is set equal to 124 (mm), while the diameter of the wheel is set equal to 50 (mm). At this stage, two necessary considerations to make are that, in the design of the proposed mechanism, the verse of rotation is clockwise and, although this mechanism was created to have a slow forward stroke and a rapid return stroke, it is exploited to have a fast forward run and a slow return run. This is because the sense of rotation of the mechanical wheel is reversed with respect to the nominal one, which was originally intended to be counter clockwise. Besides, once the dimensions of the AMBU balloon are set, it is necessary to know some physical parameters related to the breathing of the patient. The fundamental medical parameters are the following:

- Volume of air to be mechanically introduced into the patient: 0.5 (l).
- Breathing frequency: 12-20 (1/min).
- Ratios of inhalation-exhalation: 1:1 (-), 1:2 (-), 1:3 (-), 1:4 (-).

Once these fundamental medical parameters are known, the design of the mechanism must be modified accordingly. Thus, a plate is placed in correspondence of the piston so that there is a certain contact area with the AMBU balloon indicated as A . Considering a volume to insufflate on an average adult patient equal to 0.5 (l), the volume is mathematically approximated as $V = cA$, where c is the piston stroke equal to 124 (mm), while the area A of the plate in contact with the AMBU balloon is equal to 4032.25 (mm²). Taking, for simplicity, a square shape for the surface associated with this area, the dimensions of the two sides are L_1 and L_2 both equal to 63.5 (mm). At this stage, to effectively carry out the kinematic analysis of the quick return mechanism analyzed herein, consider the schematic shown in Figure 3, in which, for simplicity, a different definition of the angular displacement θ is adopted to highlight the mechanism geometric properties. By defining the geometric quantities $\overline{OH} = h$ and $\overline{PH} = r$, one has:

$$\frac{h}{\sin(\pi - (\theta + \frac{\pi}{2} + \varphi))} = \frac{r}{\sin(\varphi)} \quad (11)$$

Hence, by setting $\lambda = r/h$, one can write:

$$\tan(\varphi) = \frac{\lambda \cos(\theta)}{1 + \lambda \sin(\theta)} \quad (12)$$

Considering the definition of the angular velocity of the wheel given by $\omega = d\theta/dt$, it is possible to calculate through suitable algebraic manipulations the angular velocity of the glyph denoted with $\dot{\varphi}$ and its angular acceleration denoted with $\ddot{\varphi}$ as follows:

$$\begin{cases} \dot{\varphi} = -\frac{\lambda(\lambda + \sin \theta)}{1 + \lambda^2 + 2\lambda \sin \theta} \omega \\ \ddot{\varphi} = \frac{\lambda(\lambda^2 - 1)\cos \theta}{(1 + \lambda^2 + 2\lambda \sin \theta)^2} \omega^2 \end{cases} \quad (13)$$

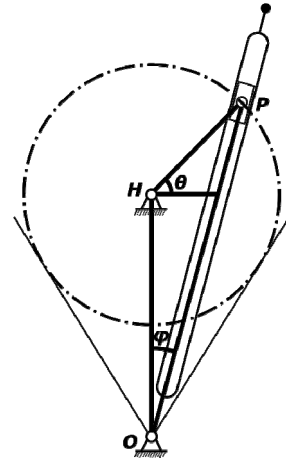

Figure 3. Kinematic schematization of the quick return mechanism

Thus, once the angular position θ , the angular velocity $\omega = \dot{\theta}$, and the angular acceleration $\alpha = \ddot{\theta}$ of the driving crank are known, one can approximately determine the linear position s , the linear velocity v , and the linear acceleration a of the piston as follows:

$$\begin{cases} s = L \sin(\varphi) \approx L\varphi \\ v \approx L\dot{\varphi} \\ a \approx L\ddot{\varphi} \end{cases} \quad (14)$$

It the previous equations, for simplicity, the assumption of small angular displacements is employed for the angle φ , which is reasonably acceptable considering the geometric dimensions of the quick return mechanism considered in this work.

3.2 Presentation of the Numerical Results: Case Study 1

The following numerical results refer to a set of fixed parameters which, however, can be arbitrarily changed in the virtual model. For example, the following numerical results were obtained considering a respi-ration rate value equal to 16 (1/min) and assuming, for simplicity, the case of the I:E ratio equal to 1:2 (with a constant angular velocity ω) and the case of the I:E ratio equal 1:3 ratio (with a variable angular velocity ω). In particular, the first case studied is the 1:2 ratio. When this parameter is set for the mechanism, the geometry is modified accordingly in order to have θ_1 equal to 240° and θ_2 equal to 120° . Thus, the ratio 1:2 is obtained by imposing a constant angular velocity ω . Knowing that the respiratory frequency is the following:

$$f = 16 \text{ (1/min)} \quad (15)$$

The constant angular velocity ω of the crank is calculated as:

$$\omega = \frac{2\pi f}{60} = 1.675 \text{ (rad/s)} \quad (16)$$

It is also possible to calculate the period T as:

$$T = \frac{1}{f} 60 = 3.75 \text{ (s)} \quad (17)$$

Then, to calculate the inhalation period T_i and the exhalation period T_e , one can write:

$$\begin{cases} \frac{T_e}{T_i} = 2 \text{ (s)} \\ T_i + T_e = 3.75 \text{ (s)} \end{cases} \Rightarrow \begin{cases} T_i = 1.25 \text{ (s)} \\ T_e = 2.5 \text{ (s)} \end{cases} \quad (18)$$

The figures shown below represent the results obtained through the simulation carried out using SIMSCAPE MULTIBODY software [26-28], and the analytical results obtained by performing the kinematic analysis of the mechanism.

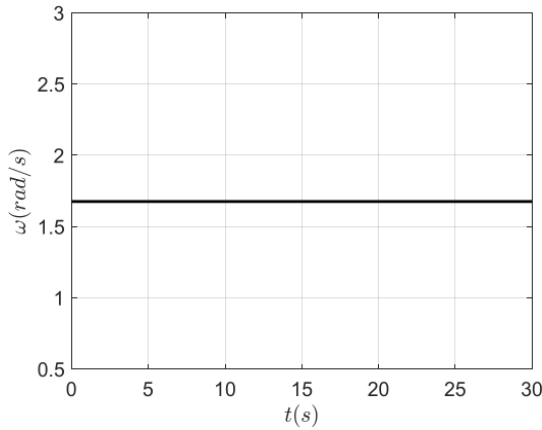

Figure 4. Angular velocity of the crank - case study 1

In Figure 4, the angular velocity of the crank is shown for the first case study. In Figure 5, the displacement of the piston is represented for the first case study. In the plot of the piston displacement shown in Figure 5, the circle markers refer to the analytical results, while the square markers refer to the numerical results. In Figure 6, the volume of air insufflated to the patient is shown for the first case study.

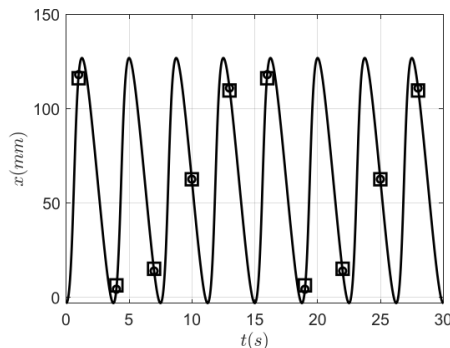

Figure 5. Piston displacement - analytical results (circle markers) and numerical results (square markers) - case study 1

Observing the plot of the volume time law, it can be seen that, in the LDC, which is characterized by the vertical dotted line that coincides with the valley of the curve, the volume administered is 0 (ml), while, in the

TDC, which is characterized by the vertical dotted line that coincides with the crest of the wave, the volume administered is maximum and equal to 500 (ml). Therefore, the numerical results found in the first case study are consistent with what was expected.

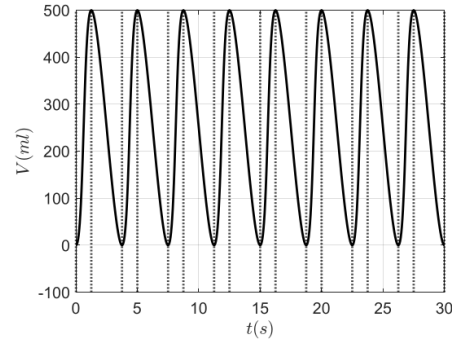

Figure 6. Volume of air insufflated into the patient - case study 1

3.3 Presentation of the Numerical Results: Case Study 2

The second and final case to study concerns the 1:3 ratio. If one wants to keep the same geometry of the quick return mechanism as in the case of the 1:2 ratio, one needs to define a variable angular velocity function ω . Therefore, this scenario is fundamentally different from the constant angular velocity function seen above for the first case study. We also want this function to be parametric and, therefore, it must be dependent on the time variable t , on the respiratory rate f , and on the ratio I:E, which is considered through the parameter R , being:

$$I : E = 1 : R \Leftrightarrow \frac{I}{E} = \frac{1}{R} \quad (19)$$

The period T of the analytical function to be constructed, as mentioned before, is defined as follows:

$$T = \frac{1}{f} 60 \quad (20)$$

Therefore, one can write the inspiration period T_i as:

$$T_i = \frac{T}{1+R} \quad (21)$$

Consequently, the expiration period T_e can be explicitly computed as:

$$T_e = T - T_i \quad (22)$$

Now one can calculate the different values of the angular velocity for the inspiration ω_i and the angular velocity for the exhalation ω_e as follows:

$$\begin{cases} \omega_i = \frac{2\pi/3}{T_i} \\ \omega_e = \frac{4\pi/3}{T_e} \end{cases} \quad (23)$$

By defining a small period of time T_ε , in which the function is properly interpolated so that it is continuous, one obtain a piecewise function given by:

$$\left\{ \begin{array}{l} \omega = \omega_i, 0 \leq t < T_i - T_\varepsilon \\ \omega = At^3 + Bt^2 + Ct + D, T_i - T_\varepsilon \leq t < T_i \\ \omega = \omega_e, T_i \leq t < T - T_\varepsilon \\ \omega = A't^3 + B't^2 + C't + D', T - T_\varepsilon \leq t < T \end{array} \right. \quad (24)$$

The two time-dependent cubic functions defined for the transient period T_ε have four characteristic constants each, that is, $A, B, C,$ and D for the first cubic function, and A', B', C' and D' for the second cubic function. To determine the characteristic parameters of the cubic functions, four boundary conditions must be imposed for each function. For the first cubic function, one can write:

$$\left\{ \begin{array}{l} \omega(t = T_i - T_\varepsilon) = \omega_i \\ \frac{d\omega}{dt}(t = T_i - T_\varepsilon) = 0 \\ \omega(t = T_i) = \omega_e \\ \frac{d\omega}{dt}(t = T_i) = 0 \end{array} \right. \quad (25)$$

This set of boundary conditions leads to the following system of linear algebraic equations:

$$\left\{ \begin{array}{l} AT_{i,\varepsilon}^3 + BT_{i,\varepsilon}^2 + CT_{i,\varepsilon} + D = \omega_i \\ 3AT_{i,\varepsilon}^2 + 2BT_{i,\varepsilon} + C = 0 \\ AT_i^3 + BT_i^2 + CT_i + D = \omega_e \\ 3AT_i^2 + 2BT_i + C = 0 \end{array} \right. \quad (26)$$

where $T_{i,\varepsilon} = T_i - T_\varepsilon$. By solving this system of four equations in four unknowns, it is possible to calculate the constants $A, B, C,$ and D . They assume the following values:

$$\left\{ \begin{array}{l} A = \frac{2(\omega_i - \omega_e)}{T_\varepsilon^3} \\ B = \frac{3(\omega_i - \omega_e)(T_\varepsilon - 2T_i)}{T_\varepsilon^3} \\ C = 6(\omega_i - \omega_e) \left(\frac{T_i^2}{T_\varepsilon^3} - \frac{T_i}{T_\varepsilon^2} \right) \\ D = \omega_e + (\omega_e - \omega_i) \left(2\frac{T_i^3}{T_\varepsilon^3} - 3\frac{T_i^2}{T_\varepsilon^2} \right) \end{array} \right. \quad (27)$$

By employing a similar procedure, the constants A', B', C' and D' can be readily calculated as follows:

$$\left\{ \begin{array}{l} A' = \frac{2(\omega_e - \omega_i)}{T_\varepsilon^3} \\ B' = \frac{3(\omega_e - \omega_i)(T_\varepsilon - 2T)}{T_\varepsilon^3} \\ C' = 6(\omega_e - \omega_i) \left(\frac{T^2}{T_\varepsilon^3} - \frac{T}{T_\varepsilon^2} \right) \\ D' = \omega_i + (\omega_i - \omega_e) \left(2\frac{T^3}{T_\varepsilon^3} - 3\frac{T^2}{T_\varepsilon^2} \right) \end{array} \right. \quad (28)$$

It is now possible to fully analyze the case study in which the ratio 1:3 is considered. Since in this second case study the period T is equal to 3.75 (s), the inspiration period T_i and the expiration period T_e can be obtained as:

$$\left\{ \begin{array}{l} \frac{T_e}{T_i} = 3 \text{ (s)} \\ T_i + T_e = 3.75 \text{ (s)} \end{array} \right. \Rightarrow \left\{ \begin{array}{l} T_i = 0.9375 \text{ (s)} \\ T_e = 2.8125 \text{ (s)} \end{array} \right. \quad (29)$$

Consequently, the angular velocities of inspiration ω_i and expiration ω_e are respectively given by:

$$\left\{ \begin{array}{l} \omega_i = 2.234 \text{ (rad/s)} \\ \omega_e = 1.489 \text{ (rad/s)} \end{array} \right. \quad (30)$$

Through the dynamical simulations performed using the SIMSCAPE MULTIBODY software [26-28], the numerical results were obtained for the second case study and are shown in the figures reported below. In figure 7, the angular velocity of the crank is shown for the second case study. In figure 8, the displacement of the piston is represented for the second case study. In figure 9, the volume of air insufflated to the patient is shown for the second case study. As in the first case study in which the ratio 1:2 is considered, by observing the plot of the volume time law in the second case study, it can be seen that in the LDC, which is characterized by the vertical dotted line that coincides with the valley of the curve, the volume administered is 0 (ml) while in the TDC, which is characterized by the vertical dotted line that coincides with the crest of the wave, the volume administered is maximum and equal to 500 (ml).

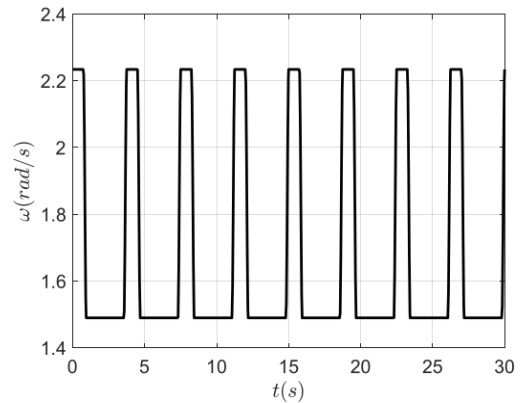

Figure 7. Angular velocity of the crank - case study 2

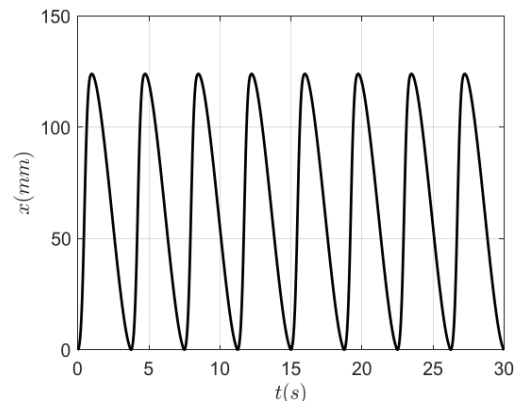

Figure 8. Piston displacement - case study 2

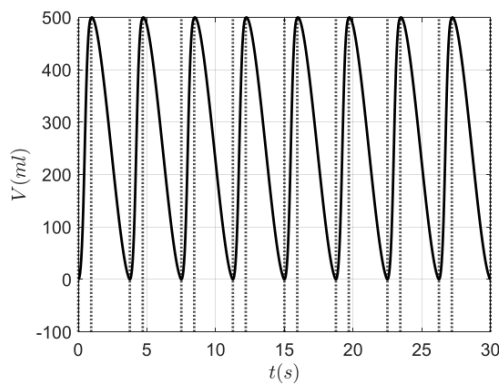

Figure 9. Volume of air insufflated into the patient - case study 2

Again, the numerical results found in the second case study are consistent with what was intuitively expected [29-32].

3.4 General Discussion

The virtual prototype of the emergency mechanical ventilator developed in this paper is shown in Figure 1. A schematic representation of the quick return mechanism that stands behind its design is shown in Figure 2, while Figure 3 clarifies the kinematic schematization of this mechanism. The geometry of this articulated mechanical system, modeled as a multibody system, is designed to comply with three fundamental medical parameters: the volume introduced into the patient, the breathing frequency, and the ratio of the inhalation-exhalation periods. To this end, two case studies are considered, namely the case in which one has the 1:2 inhalation-exhalation ratio (case study 1) and the case in which one has the 1:3 inhalation-exhalation ratio (case study 2). Therefore, the machine design is focused on these two scenarios that are relevant for medical applications. As can be seen in Figures 4, 5, and 6, particularly by observing the two curves identified by the circle and square markers, the curves do not overlap perfectly in the 1:2 ratio corresponding to the first case study. However, there is still a good agreement between the analytical and the numerical results. However, the numerical results differ slightly from the analytical ones. Some simplifications related to the nonlinearity of the geometric equations have been made, but the results are still acceptable. In the second case study in which the 1:3 ratio is considered, the numerical results presented in the paper are obtained only using numerical simulations performed by employing the SIMSCAPE MULTIBODY software. This second case study shows the numerical results in Figures 7, 8, and 9. This is necessary because the angular velocity of the crank is not constant, and this implies the impossibility of a reasonable analytical study of the quick return mechanism. Nevertheless, even in the second case study, the numerical results are consistent with what is expected from the correct functioning of the emergency mechanical ventilator. The numerical results reported in this section were determined by the combined use of the multibody approach and the computer-aided analysis approach of articulated mechanical systems adopted throughout this paper [33-35].

4. SUMMARY, CONCLUSIONS, AND FUTURE WORK

In summary, this paper presents the main aspects of developing a simple but effective mechanism with a planar motion that can be easily employed to control a mechanical pulmonary ventilator's dynamic behavior properly. In particular, the fundamental objective was to design a low-cost, space-saving, and easy-tunable mechanism that can meet all the medical parameters required for artificial pulmonary respiration without the use of electronic components, thereby focusing only on the mechanical parts of the virtual prototype. This was done by using a systematic and innovative approach aimed at the direction of the Integration of Computer-Aided Design and Analysis (I-CAD-A). To this end, a virtual prototype was designed in this work considering a three-dimensional environment, and its kinematic and dynamic features were simulated to optimize the fundamental medical parameters of artificial pulmonary respiration. The software used for the three-dimensional CAD design was SOLIDWORKS. Furthermore, the computer program employed for developing the multibody model of the articulated system of interest and for carrying out the numerical experiments was SIMSCAPE MULTIBODY, a general-purpose analysis tool belonging to the MATLAB family. The main numerical results obtained through virtual simulations are encouraging. Indeed, after several trials and errors that characterized the iterations of the design process, the final version of the virtual prototype can guarantee all the design goals set at the beginning of this project. The synergic use of integrated computer-aided analysis and design tools based on the multibody system approach allowed for achieving these goals. In subsequent works, further developments will be focused on transforming the virtual prototype into an actual test rig.

The work carried out in this study needs further experimental investigations, especially regarding the control of the various medical quantities involved in artificial respiration. As mentioned before, future developments will be focused on constructing a physical prototype of the articulated mechanism devised in this investigation. Several issues must be addressed in future works with the help of a physical prototype to verify the feasibility and effectiveness of the solution proposed in this work, which focused only on the design of the virtual prototype. For example, the dynamical simulations based on the virtual prototype designed in this paper evidenced some possible issues in the numerical results, which might be unfeasible or unacceptable during the actual functioning of the mechanism, such as some acceleration peaks that occur in a very short time. However, in general, these issues do not preclude the possibility of developing an actual physical prototype, which is suitable for the main goal of this project and is based on a modified version of the virtual prototype developed in this work. For instance, the presence of the acceleration peaks could be harmless for the actual prototype and, more importantly, for the patient, or could be easily removed by developing a modified version of the mechanical pulmonary ventilator equipped with an appropriate control system. These interesting issues will be addressed in future investigations.

REFERENCES

- [1] Shabana, A. A.: *Dynamics of multibody systems*, Cambridge University Press, 2003.
- [2] Vinogradov, O.: *Fundamentals of Kinematics and Dynamic of Machines and Mechanisms*, CRC Press LLC, 2000.
- [3] Jacazio, G., Piombo, B.: *Meccanica Applicata alle Macchine Vol. I, Principi Generali di Meccanica*, Libreria editrice universitaria Levrotto e Bella, 1990.
- [4] Jacazio, G., Piombo, B.: *Meccanica Applicata alle Macchine Vol. II, La Trasmissione del Moto*, Libreria editrice universitaria Levrotto e Bella, 1992.
- [5] Funaioli, E., Maggiore, A., Meneghetti, U.: *Lezioni di Meccanica Applicata alle Macchine Vol. I*, Pàtron editore, 1987.
- [6] Funaioli, E., Maggiore, A., Meneghetti, U.: *Lezioni di Meccanica Applicata alle Macchine Vol. II*, Pàtron editore, 1998.
- [7] Miller, S., Wendlandt, J.: Real-time simulation of physical systems using simscape, *MATLAB News and Notes*, pp. 1-13, 2010.
- [8] Hong, X. I. E., and Wei, S. H. I.: Using SolidWorks 2000 software to design three-dimensional modeling for assembled part [J], *Machinery Design & Manufacture*, Vol. 1, pp. 35-36, 2002.
- [9] Zhou, M., Zhang, X., Qu, J.: Coronavirus disease 2019 (COVID-19): a clinical update, *Frontiers of medicine*, Vol. 14, No. 2, pp. 126-135, 2020.
- [10] Downs, J. B., Klein Jr, E. F., Desautels, D., Modell, J. H., and Kirby, R. R.: Intermittent Mandatory Ventilation: A New Approach to Weaning Patients from Mechanical Ventilators, *Chest*, Vol. 64, No. 3, pp. 331-335, 1973.
- [11] Ziehr, D. R., Alladina, J., Petri, C. R., Maley, J. H., Moskowitz, A., Medoff, B. D., and Hardin, C. C.: Respiratory pathophysiology of mechanically ventilated patients with COVID-19: a cohort study, *American journal of respiratory and critical care medicine*, Vol. 201, No. 12, pp. 1560-1564, 2020.
- [12] Al Hussein, A. M., Lee, H. J., Negrete, J., Powelson, S., Servi, A. T., Slocum, A. H., Saukkonen, J.: Design and prototyping of a low-cost portable mechanical ventilator, *Transactions of the ASME-W-Journal of Medical Devices*, Vol. 4, No. 2, 027514, 2010.
- [13] Shahid, M.: Prototyping of artificial respiration machine using AMBU bag compression, in: *IEEE 2019 International Conference on Electronics, Information, and Communication (ICEIC)*, pp. 1-6, 2019.
- [14] Kwon, A. H., Slocum, A. H., Varelmann, D., and Nabzdyk, C. G.: Rapidly scalable mechanical ventilator for the COVID-19 pandemic, *Intensive care medicine*, Vol. 46, No. 8, pp. 1642-1644, 2020.
- [15] Tsuzuki, M. S., Martins, T. C., Takimoto, R. T., Tanabi, N., Sato, A. K., Scaff, W., and Horikawa, O.: Mechanical Ventilator VENT19. *Polytechnica*, Vol. 4, No. 1, pp. 33-46, 2021.
- [16] Abba, A., Accorsi, C., Agnes, P., Alessi, E., Amaudruz, P., Annovi, A., and Natzke, C. R.: The novel Mechanical Ventilator Milano for the COVID-19 pandemic, *Physics of Fluids*, Vol. 33, No. 3, 037122, 2021.
- [17] Ait-Khaled, N., Enarson, D., and Bousquet, J.: Chronic respiratory diseases in developing countries: the burden and strategies for prevention and management, *Bulletin of the World Health Organization*, Vol. 79, pp. 971-979, 2001.
- [18] Slavitt, A.: The COVID-19 pandemic underscores the need to address structural challenges of the US health care system, in: *JAMA Health Forum, American Medical Association*, Vol. 1, No. 7, pp. e200839-e200839, 2020.
- [19] Morris, K. V., The improbability of the rapid development of a vaccine for SARS-CoV-2, *Molecular Therapy*, Vol. 28, No. 7, pp. 1548-1549, 2020.
- [20] Peebles, L.: News Feature: Avoiding pitfalls in the pursuit of a COVID-19 vaccine, *Proceedings of the National Academy of Sciences*, Vol. 117, No. 15, pp. 8218-8221, 2020.
- [21] Zeigler, B. P., Muzy, A., and Kofman, E.: *Theory of modeling and simulation: discrete event e iterative system computational foundations*, Academic press, 2018.
- [22] Xie, P., Li, Z., and Tian, Z.: The optimal combination of mechanical ventilator parameters under general anesthesia in obese patients undergoing laparoscopic surgery, *Journal of clinical anesthesia*, Vol. 34, pp. 290-294, 2016.
- [23] Arrieta, A.: Variability Modeling and Management of MATLAB/Simulink Models, in: *Proceedings of the 23rd International Systems and Software Product Line Conference*, Volume A, pp. 332-332, 2019.
- [24] Deatcu, C., Pawletta, T., Folkerts, H.: MATLAB/Simulink's Variant Manager vs SEStoPy, *Simul. Notes Eur.*, Vol. 29, No. 1, pp. 39-43, 2019.
- [25] Cooke, R., Nicholas, O. Roy, H.: Ventilator for Rapid Response to Respiratory Disease Conditions, U.S. Patent Application No. 11/678,201, 2007.
- [26] Chaturvedi, D. K.: *Modeling and simulation of systems using MATLAB and Simulink*, CRC press, 2017.
- [27] Klee, H., Allen, R.: *Simulation of dynamic systems with MATLAB and Simulink*, CRC Press, 2016.
- [28] Naldi, G., Pareschi, L.: *Matlab. Concetti e progetti*, Apogeo Editore, 2002.
- [29] Pappalardo, C. M., Lettieri, A., and Guida, D.: A General Multibody Approach for the Linear and Nonlinear Stability Analysis of Bicycle Systems. Part I: Methods of Constrained Dynamics, *Journal of Applied and Computational Mechanics*, Vol. 7, No. 2, pp. 655-670, 2021.

- [30] Pappalardo, C. M., Lettieri, A., and Guida, D.: A General Multibody Approach for the Linear and Nonlinear Stability Analysis of Bicycle Systems. Part II: Application to the Whipple-Carvallo Bicycle Model, *Journal of Applied and Computational Mechanics*, Vol. 7, No. 2, pp. 671-700, 2021.
- [31] Ardila-Parra, S. A., Pappalardo, C., Estrada, O. A. G., and Guida, D.: Finite Element based Redesign and Optimization of Aircraft Structural Components using Composite Materials, *IAENG International Journal of Applied Mathematics*, Vol. 50, No. 4, pp. 1-18, 2020.
- [32] Pappalardo, C. M., Guida, D.: Dynamic Analysis and Control Design of Kinematically-Driven Multibody Mechanical Systems. *Engineering Letters*, Vol. 28, No. 4, pp. 1125-1144, 2020.
- [33] Lommen, S. W., Schott, D. L., and Lodewijks, G.: Multibody Dynamics Model of a Scissors Grab for Co-Simulation with Discrete Element Method. *FME Transactions*, Vol. 40, No. 4, pp. 177-180, 2012.
- [34] Čajić, M. S., Lazarević, M. P.: Determination of Joint Reactions in a Rigid Multibody System, Two Different Approaches. *FME Transactions*, Vol. 44, No. 2, pp. 165-173, 2016.
- [35] Zorić, N. D., Lazarević, M. P., and Simonović, A. M.: Multi-Body Kinematics and Dynamics in terms of Quaternions: Langrange Formulation in Covariant Form: Rodriguez Approach. *FME Transactions*, Vol. 38, No. 1, pp. 19-28, 2010.

Acronyms

AMBU	Artificial Manual Breathing Unit
CAD	Computer-Aided Design
I-CAD-A	Integration of Computer-Aided Design and Analysis
I:E	Inhalation-Exhalation Ratio
LDC	Lower Dead Center

MBD	Multi-Body Dynamics
ODE	Ordinary Differential Equation
TDC	Top Dead Center
WHO	World Health Organization

РАЗВИЈАЊЕ РЕЦИПРОЧНОГ МЕХАНИЗМА ЗА ХИТНУ ИМПЛЕМЕНТАЦИЈУ МЕХАНИЧКОГ ПЛУЋНОГ ВЕНТИЛАТОРА КОРИСТЕЊИ ИНТЕГРИСАЊУ САД-MBD ПРОЦЕДУРУ

К.М. Папалардо, А. Веће, Д. Галди, Д. Гуида

Након избијања COVID-19, редизајн хитног механичког плућног вентилатора који је јефтин и лако преносив постао је неопходан у неколико контекста, као што су хитне тачке и окружења са лошим ресурсима. Да би се решило ово важно питање, у овом раду је коришћен општи приступ са више тела за развој клипног механизма погодног за накнадну уградњу постојећих ручних механичких вентилатора помоћу компјутерски потпомогнутих инжењерских алата.

Анализом различитих основних зглобних механизма који се обично налазе у инжењерској механици, прототип се креира и репродукује у тродимензионалном окружењу коришћењем SO-LIDWORKS-овог САД софтвера. Након тога, развијен је механички модел високе верности почевши од САД геометрије и коришћењем SIMSCAPE MULTIBODY софтвера, проширења MATLAB породице програма који могу ефикасно и ефикасно да изводе кинематичке и динамичке симулације механизма од интереса. Као што је објашњено у раду, извођењем бројних нумеричких експеримената, виртуелне симулације предвиђају неколико фундаменталних медицинских параметара, као што су проток ваздуха који се уводи у пацијенте, брзина дисања и респираторни однос.