

Mobile Technology Module for Pipeline Maintenance: Design and Simulation

M. Polishchuk

Associate Professor
National Technical University of Ukraine
Department of Information Systems and
Technologies
Ukraine

V. Yahlinskyi

Professor
Odessa National Polytechnic University
Department of Lifting-Transport and Robotic
Equipment
Ukraine

Modern pipeline communications require periodic maintenance for various purposes, such as gas, oil, water station pipes, chimneys, and other pipelines. Such maintenance involves transport devices that operate autonomously inside pipelines, including in vertical tubes, and perform various technological operations, such as diagnosing the internal state of pipes, cleaning them, applying protective coatings, machining, welding, and the like processes.

The article proposes a fundamentally new design of a mobile technological module for servicing the internal surfaces of pipelines. The main advantage of the proposed module is its ability to move along vertical pipelines of various diameters while overcoming the gravitational load. This effect is achieved by using elastic chambers in the module design. When compressed air or pressurized liquid is supplied to them, they periodically fix the module on the internal surfaces of the pipelines. The main economic effect is to reduce the cost of preventive maintenance to maintain the interior surfaces of vertical pipelines, that is, without their dismantling and with the simultaneous possibility of adapting transport devices to the pipeline topology. The article offers a description of the new design of the technological module and analytical dependencies for calculating the design parameters of the module. The results of modeling the parameters of the module are presented.

Keywords: transport module, vertical pipelines, elastic chambers, pipe service

1. INTRODUCTION

In modern industry, pipeline communications are often used for various industrial and municipal purposes, requiring periodic maintenance. Different transport devices have already been created to service the outer surfaces of such pipelines. However, for the technical maintenance of the internal surfaces of pipelines, technical solutions are minimal. Of particular relevance is the problem of creating transport technological devices for moving inside vertical pipelines when it is necessary to overcome the gravitational load to keep these devices on the inner surfaces of pipes during various technical operations. Such operations include video surveillance, diagnostics of the internal state of pipes, their cleaning and application of protective coatings, machining, welding, and similar processes. In addition, technological devices for servicing the interior surfaces of pipelines must have the property of mobility and the possibility of remote control.

The primary motivation for creating a technological module is to reduce the cost of preventive maintenance

for maintaining the internal surfaces of vertical pipelines due to the lack of dismantling of pipeline connections. At present, the repair or maintenance of the interior surfaces of pipes necessitates the dismantling of pipelines, which further increases the cost of operating pipeline communications. The proposed technological module can carry out various technical operations inside pipelines without dismantling pipe connections. The module can move inside vertical pipes and periodically fix on the walls of pipes to overcome the gravitational component of the total load from its weight and technological efforts. A fundamentally new module design (Patent UA 118921) contains elastic chambers with protectors to securely hold the device on the inner surface of vertical pipes. Module fixing forces occur when compressed air or pressurized fluid is supplied to the elastic chambers, depending on the technological purpose of the module. The article also proposes analytical dependencies for calculating the design parameters of the module and the results of modeling the module parameters.

2. PREREQUISITES AND MEANS FOR SOLVING THE PROBLEM

The problem with creating transport devices for moving inside pipelines is that these devices must be held on the internal surfaces of the pipes and be able to move inside

Received: July 2021, Accepted: February 2022
Correspondence to: M. Polishchuk, Associate Professor
National Technical University of Ukraine, Department
of Information Systems and Technologies, Ukraine
E-mail: borchiv@ukr.net
doi:10.5937/fme2201360P

© Faculty of Mechanical Engineering, Belgrade. All rights reserved

FME Transactions (2022) 50, 360-368 **360**

the pipes. Currently, several original designs of these transport devices are known. For example, a transport apparatus for overcoming obstacles is known, which has two technical implementations [1] and [2]. In the first case, the device contains a drive shaft, which kinematically connects several segments connected by hinges. Each device segment has two degrees of freedom and is made in the form of revolving joints. These joints are placed at an angle of 90° and are equipped with pneumatic reins. In the second case [2], the device is made in an elongated flexible body, which comprises separate sections with two degrees of freedom. These sections are hinged and actuated by individual actuators. Both devices have increased cross-country ability to overcome various obstacles and, among other operations, can clean the internal surfaces of pipelines. However, these devices cannot move along vertical pipelines, that is, move with overcoming the gravitational load. This property limits their technological capabilities.

Of no less interest is the vehicle [3] named "Serpentine-Robot Omni tread," which is designed for autonomous movement during the inspection of Industrial facilities, including pipelines. This robot comprises five segments connected by joints with two degrees of freedom and equipped with caterpillar tracks in two mutually perpendicular planes. Unlike the two previous technical solutions, this device can move along inclined surfaces, including pipes at an angle to the horizon within $22^\circ \dots 30^\circ$. However, due to the low adhesion to the moving surface, this device can also not move along vertical pipes. A promising technical solution is a vehicle [4] containing two identical final modules. A Hooke hinge connects these modules with an elastic element. The device can move inside pipelines. However, because the drives of the modules have a rigid design with a constant size, this device cannot move through internal pipelines of various sections, for example, conical pipes or pipes with a significant difference in their diameters.

The vehicle [5] is designed to move in soils of various kinds and pipes. The device contains several separate sections, which are provided with means of fixation relative to the moving surface. The means of movement are hydrogen-filled bellows. The vehicle's execution in the form of bellows does not allow a hefty load capacity and cannot take the load of technological operations. The vehicle [6] contains links of empty cylinders, in which there are devices for fixing the vehicle inside the pipe. The fixing devices are equipped with an elastic film, which is squeezed out under the action of hydrogen to repair the vehicle. This property allows the device to move in vertical pipes but only in pipes of a constant cross-section. In cases of pipes of the variable cross-section with a significant difference in their diameters, this device cannot be applied.

When performing operations such as pipe welding, it is essential to use methods for assessing the quality of welded pipelines [7, 8] and new technologies [9] and equipment for in-line inspection of pipelines that serve mobile technological modules. A promising direction for creating these modules can be the walking mechanisms of robots [10, 11], which increase adhesion

to the internal surfaces of pipelines. When using modules for cleaning pipelines, it is advisable to consider the heat transfer simulation with the mechanical distribution of liquid [12]. The robot [13] for diagnosing and cleaning pipelines has an original design. This robot is equipped with a caterpillar transmission mounted on articulated parallelograms, which allows the robot to service pipelines with a diameter of 200 mm to 1350 mm. However, to solve the above problem, it is necessary to create original designs and the application of methods for attesting the kinematic characteristics of manipulators of industrial robots [14], as well as taking into account the dialectics of the development of transport vehicles [15]. Thus, the above analysis of technical solutions and studies shows that the task of synthesizing a mobile technological module for pipeline maintenance remains relevant.

3. FORMULATION OF THE PROBLEM

To reduce the cost of preventive maintenance when servicing the internal surfaces of vertical pipelines, it is necessary to create a technological module for moving inside vertical pipes with a periodic fixation on the pipe walls to overcome the gravitational component of its weight and technical efforts. In addition, the module must be able to adapt to pipes of various diameters, including adaptation to conical pipes with a variable diameter. It is necessary to develop analytical dependencies for calculating the parameters of the specified module, which will enable engineers in this field to design such devices.

4. SOLUTION OF THE PROBLEM UNDER CONSIDERATION

The engineering novelty of the proposed technical solutions lies in a fundamentally new design of a mobile technological module [16] for servicing the internal surfaces of pipelines, and analytical dependencies represent the scientific novelty for calculating the parameters and modeling the specified module. The primary motivation of this research is the creation of a technological module that will allow performing maintenance work inside vertical pipelines without dismantling individual sections of pipelines. This property will significantly reduce the maintenance cost of industrial pipelines for various purposes.

4.1 Technological module design

Figure 1 shows a 3D model of the technological module in a quarter section with the module located on the inner surface of the pipeline, for example, in a conical shape. The main elements of the module are the upper and lower platforms, on which the upper and lower elastic chambers are fixed with clamps, respectively. Protectors are made on the outer surface of the elastic chambers for better adhesion to the pipeline walls. These platforms are connected by a rod with a mechanical spring, protected from damage by a corrugated casing. The upper end of the specified rod is connected to the diaphragm of a pneumatic or hydraulic drive located in

the upper platform. The type of drive – pneumatic or hydraulic – is selected depending on the required load capacity of the module.

Through channel 1, pressure is created in cavity «B,» i.e., under the diaphragm, and through channel 2, pressure is made in cavity «C,» i.e., above the diaphragm. Channels 3 and 4 supply compressed air or fluid under pressure to the upper or lower chambers. The lower end of the above rod is connected to the lower platform through a spherical hinge. This spherical joint allows platforms to compensate for pipeline bends. In addition, the technological module is equipped with a power supply and a pressure generator.

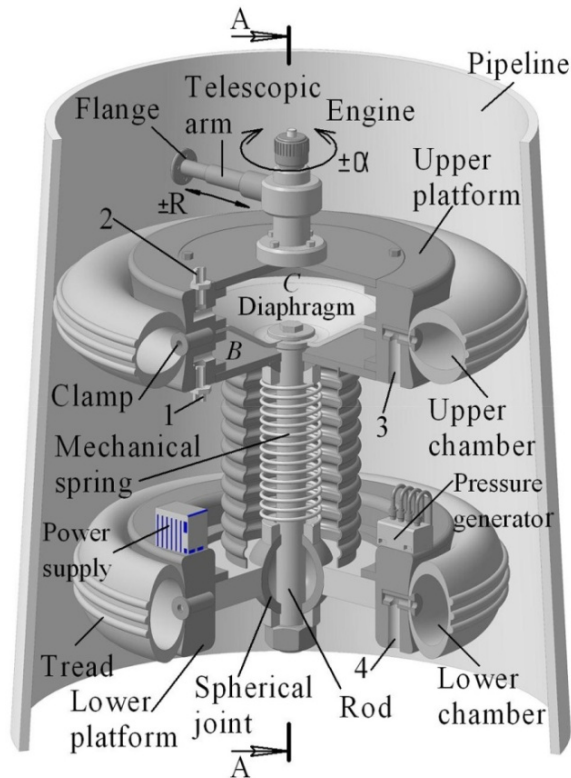

Figure 1. Mobile technological module in a quarter section

To perform technological operations, a telescopic arm is installed on the upper platform, which extends by $\pm R$ and has a motor that rotates the arm through an angle of $\pm \alpha$. As shown in Figure 1, the telescopic arm flange is designed to accommodate various process equipment. Such equipment is determined by the type of technological operations, such as diagnostics of the internal state of pipes, their cleaning and application of protective coatings, machining, welding, and similar processes.

The module's movement sequence inside the pipeline is shown in Figure 2. The distance between the upper and lower platforms is the dimension "A" in the initial position. When installing the module in a cylindrical or conical pipeline with a taper angle " β ," through channel 3 (see Figure 2, a), pressure is created (compressed air or liquid under pressure) in the upper elastic chamber of the upper platform. Under pressure, the upper chamber expands and fixes the module in the pipeline due to friction forces " F " and regular reaction forces " N ." This allows the module to overcome the gravitational load due to the force of the weight mg .

Then, at the control system's command, pressure is created through channel 1 in cavity "B" under the diaphragm, which, using a rod, moves the lower platform by the amount S_1 . This compresses the mechanical spring, which is placed on the specified rod. As a result, the distance between the upper and lower platforms will be $A - S_1$. Further, as shown in Figure 2(b), pressure is created through channel 4 in the lower elastic chamber, which allows it to fix the module on the pipeline walls. After this action, the pressure in the upper chamber and cavity "B" under the diaphragm is relieved. Then through channel 2, pressure is created in the cavity "C" above the diaphragm. As a result of this pressure and under the action of a mechanical spring, the upper platform moves by the amount $S_2 = S_1$.

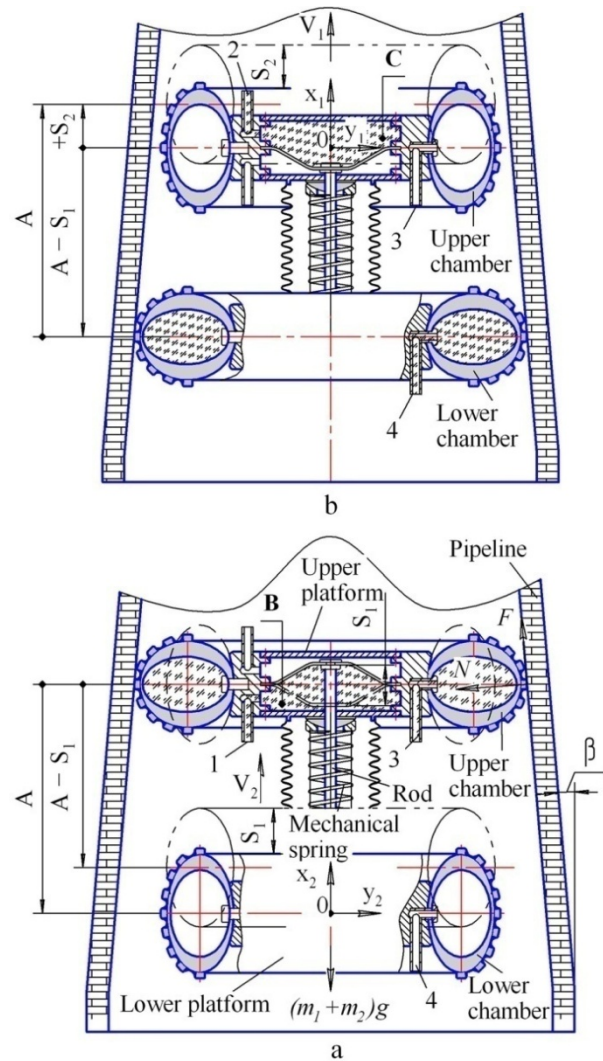

Figure 2. Longitudinal section of the module along the A-A plane (see Figure 1): m_1, m_2 – respectively, the mass of the upper and lower platforms; $g = 9,8 \text{ m/c}^2$ – gravity acceleration

As a result, the distance between the upper and lower platforms is restored and equals the dimension "A." Thus, the module has moved up the pipeline to the first step, namely the value " S_2 ." Then the cycle of movement is repeated.

The module moves inside the pipeline by sequentially creating and relieving pressure in the elastic upper and lower chambers and the cavities "B" and "C" of the diaphragm actuator. When performing

power operations using the telescopic arm (see Figure 1), it is recommended to stop the module. It is necessary to simultaneously create pressure in the upper and lower chambers for more reliable adhesion of the module to the pipeline walls. In the case of performing non-power operations, for example, such as diagnosing the condition or video surveillance of the internal pipeline, the module can not be stopped, and the pressure in these chambers can be created in turn according to the motion cycle program, as indicated above.

4.2 Simulation of a technological module

To enable engineers and researchers in the field to design such technological modules, the following are analytical dependencies and graphs that display the relationship of the design parameters of the module. Initially, the movement of the lower platform was investigated, and then the movement of the upper platform was considered. In conclusion, analytical dependencies for calculating the strength of the elastic chambers of the technological module are provided.

4.2.1. Movement of the lower platform of the module

Let us assume that the friction force F (see Figure 2, a) between the pipeline and the toroid-shaped upper chamber, which is fixed on the upper platform, is sufficiently large $F = \mu N \cos \beta > (m_1 + m_2)g$ (where: μ is the friction coefficient; N is the normal reaction force) and provides real estate (fixation) upper platform. Then the lower platform moves under the action of the force P , which arises on the rod due to the pressure p_1 in the cavity "B" and is directed vertically upwards along the x_2 axis. The weight force m_2g and the elastic force of the compressed mechanical spring, which are directed vertically downwards, will also act on the lower platform. We choose a fixed coordinate system Ox_2y_2 in the center of the initial position of the lower platform, with the Ox_2 axis directed vertically upwards.

Let us compose the differential equation of motion of the lower platform under the action of the indicated forces:

$$m_2 \frac{d^2 x_2}{dt^2} = P - cx_2 - m_2 g \quad (1)$$

where: m_2 and x_2 are the mass and coordinate of the movement of the lower platform; c – is the stiffness of the mechanical spring (N/m); the well-known formula determines force P for a diaphragm actuator

$$P = \frac{0,75\pi(D+d)^2}{16} p_1 \quad (\text{where: } D \text{ is the diameter of the}$$

diaphragm of a pneumatic or hydraulic actuator; d is the diameter of the rod (i.e., the drive rod; p_1 is the pressure under the diaphragm in cavity "B" (see Figure 2, a).

The general solution of the differential equation (1) has the form

$$x_2(t) = \frac{P - m_2 g}{c} + A_1 \cos(\omega_2 t) + A_2 \sin(\omega_2 t) \quad (2)$$

where indicated $\omega_2 = \sqrt{\frac{c}{m_2}}$. Then the speed V_2 of the

Movement of the lower platform will be

$$V_2 = \frac{dx_2}{dt} = A_2 \omega_2 \cos(\omega_2 t) - A_1 \omega_2 \sin(\omega_2 t) \quad (3)$$

The integration constants A_1 and A_2 are found from the initial conditions: at $t=0$, $x_2(0)=0$, $V_2=0$. Substituting these conditions into equations (2) and (3), we find:

$$A_1 = -\frac{P - m_2 g}{c}, A_2 = 0. \text{ We substitute these values into}$$

equations (2) and (3) and obtain the final formulas for finding the displacement x_2 and the speed V_2 of the lower platform at any time:

$$x_2(t) = \frac{P - m_2 g}{c} (1 - \cos(\omega_2 t)) \quad (4)$$

$$V_2 = \frac{P - m_2 g}{c} \omega_2 \sin(\omega_2 t).$$

And: $0 \leq x(t) \leq S_2 = 0,35D$.

Here, equality $S_2 = 0,35D$ is the standard condition for diaphragm actuator design. The stiffness value "c" of a mechanical spring can be estimated from the following considerations. When a mechanical spring is compressed under the action of the drive force P by the amount of displacement S_2 , it accumulates potential

energy $U = \frac{cS_2^2}{2}$, which is used at the next step of the

module movement to move the upper platform by the amount $S_1 = S_2$. That is, the condition must be met

$U = \frac{cS_2^2}{2} \geq m_1 g S_2$. From this condition, we obtain the

value of the stiffness of the mechanical spring:

$$c \geq \frac{2m_1 g}{S_2} \quad (5)$$

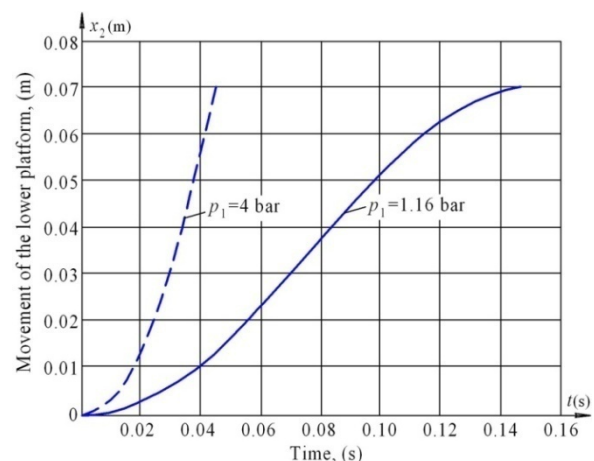

Figure 3. The dependence of the displacement of the lower platforms from time to time at different pressures p_1 in the diaphragm drive under the following conditions: $D=0.2(m)$; $d=0.04(m)$; $S_2=0.35D(m)$; $m_1=m_2=40(kg)$

According to functions (4), the simulation of movement and change in the speed of movement of the

lower platform was performed. The graphs in Figure 3 show that platform movement increases significantly with increasing pressure in the diaphragm drive. It provides sufficient movement speed for the successful operation of the module in the pressure range of 1.2...4.0 bar. Graphs in Figure 4 illustrate the change in the platform's speed, which shows the difference in the acceleration of the movement. It should be remembered here that an increase in the acceleration of movement leads to the rise in inertia forces and, hence, additional dynamic loads on the platform. Therefore, it is recommended to limit the platform's speed to the range of 1.0...2.5 (m/s), which is sufficient for the efficient industrial operation of the technological module.

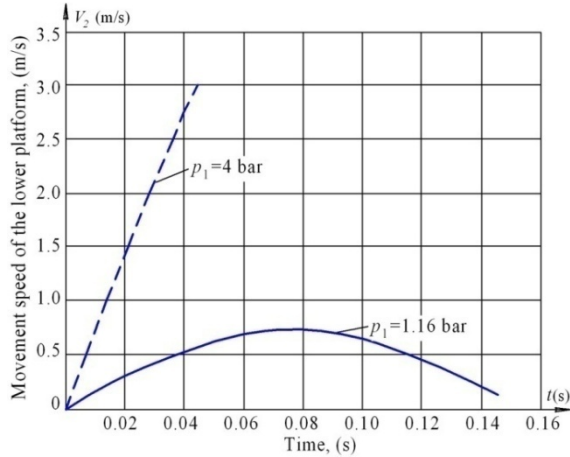

Figure 4. Change in the speed of movement of the lower platform at different pressure p_1 in the diaphragm drive under the conditions: $D=0.2(m)$; $d=0.04(m)$; $S_2=0.35D(m)$; $m_1=m_2=40(kg)$

4.2.2. movement of the upper platform of the module

When pressure is created in the lower elastic chamber, the friction force between the pipe and the lower chamber of the lower platform is sufficiently large $\mu N \cos \beta > (m_1 + m_2)g$. It ensures the immobility of the lower platform. Then the upper platform is set in motion under the action of the elastic force of the compressed mechanical spring, which is directed vertically upwards. The upper platform will also be subject to the force of the weight m_1g , which is directed vertically downwards. Let's choose an immovable coordinate system Ox_1y_1 (see Figure 2, b). The origin of the coordinate system is in the center of the initial position of the upper platform. The Ox_1 axis is directed vertically upwards. Similarly to the method for obtaining dependences (1), (2), and (3), we find formulas for the movement and speed of the upper platform at an arbitrary point in time:

$$x_1(t) = \left(S_2 - \frac{m_1g}{c}\right)(1 - \cos(\omega_1 t)), \quad (6)$$

$$V_1 = \left(S_2 - \frac{m_1g}{c}\right)\omega_1 \sin(\omega_1 t);$$

where $0 \leq x(t) \leq S_2 = 0,35D$; $\omega_1 = \sqrt{\frac{c}{m_1}}$.

Functions (6) allow you to simulate the movement and change in the speed of movement of the upper

platform, depending on the stiffness "c" of the mechanical spring, under the action of which the upper platform moves. As can be seen from the graphs in Figure 5, the amount of movement (and hence the speed) of the platform increases with increasing stiffness "c" of the mechanical spring. However, it should be taken into account that an increase in the rigidity of the mechanical spring also leads to a specific decrease in the module's efficiency. This negative effect can be compensated by changing the parameters of the diaphragm drive, namely by changing its diameter. At the same time, the value of the step of moving the module will also change because of $S_2=0.35D$.

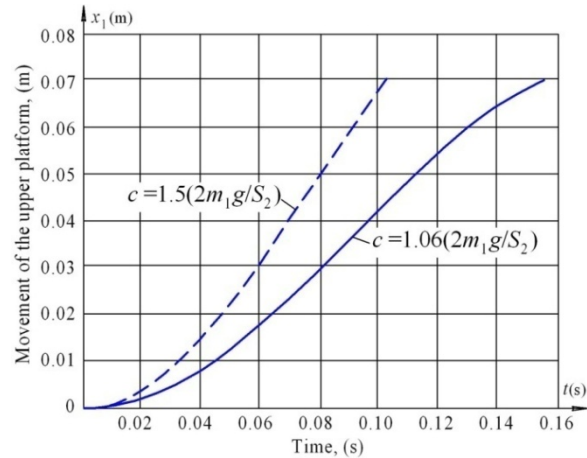

Figure 5. Influence of stiffness "c" of a mechanical spring to move the upper platform ($D=0.2(m)$; $d=0.04(m)$; $S_2=0.35D(m)$; $m_1=40(kg)$)

A similar effect is observed in the influence of the rigidity of the mechanical spring on the speed of Movement (Figure 6) of the upper platform. Therefore, for efficient operation of the module, it is recommended to vary the stiffness of the mechanical spring in proportion to the mass of the upper platform.

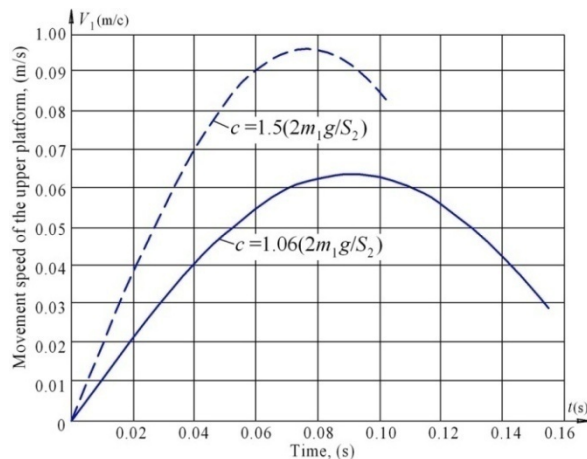

Figure 6. Influence of stiffness "c" of a mechanical spring on the speed of movement of the upper platform at $m_1=40 kg$

4.2.3. Modeling the Strength of an Elastic Chamber

For the successful operation of the module, these cameras must be designed for durability. As indicated above (see Figure 1), the main elements of the module are the upper and lower platforms, on which the upper and lower elastic chambers are fixed, respectively. The

chambers are torus-shaped (Figure 7) and made of polyvinyl chloride (PVC) material. When pressure is created in these chambers, they are deformed, and the module is fixed on the pipeline walls. We will assume that the contours of the cross-section of the chamber have the shape of ellipses, the centers of which and the axes of symmetry coincide. We choose the origin of the Oxy coordinate system at the center of the ellipses (Figure 7, see section) and direct the coordinate axes along the symmetry axes.

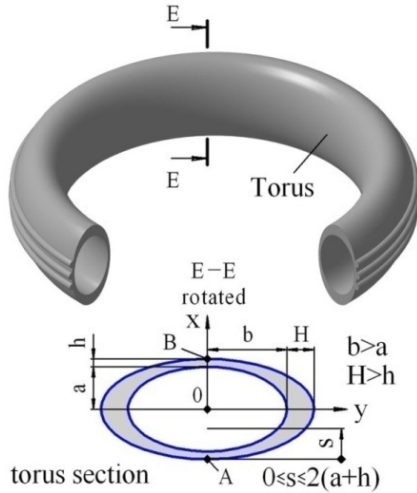

Figure 7. Elastic chamber (¼ section) in the shape of a torus and its cross-section

The equation of ellipses in this Oxy coordinate system can be written in canonical form:

$$\frac{x_1^2}{a^2} + \frac{y_1^2}{b^2} = 1; \quad \frac{x_2^2}{(a+h)^2} + \frac{y_2^2}{(b+H)^2} = 1 \quad (7)$$

where: $a, b; (b > a)$ – semi-axes of the inner ellipse: $-a \leq x_1 \leq a; -b \leq y_1 \leq b; a+h, b+H; (H > h)$ – semi-axes of the outer ellipse: $-a-h \leq x_2 \leq a+h; -b-H \leq y_2 \leq b+H$.

For the cross-section of the chamber, it is possible to compose an equilibrium equation in the projection onto the axis, which is perpendicular to the plane of the chamber section:

$$pF = \iint_{F_1} \sigma_1 dF_1 \quad (8)$$

where: p – is the pressure of compressed air or liquid under pressure in the chamber; $F = \pi ab$ – area, which is limited by an internal ellipse; the cross-sectional area of the material is: $F_1 = \pi(a+h)(b+H) - \pi ab$; σ_1 is the normal stress in the cross-sectional area of the chamber.

The section points move in the direction of the Ox axis and the movement of the point $A(-a-h, 0)$. At this point, the camera is attached to the platform, and its displacement is zero. We will assume that the displacement "u" of other points changes according to the linear law

$$u = u_B \frac{s}{2(a+h)} \quad (9)$$

where: u_B – moving point $B(a+h, 0); 0 \leq s \leq 2(a+h)$. See Figure 7.

Let us write down the expressions for the deformations "ε" of the chamber fibers and the corresponding stresses σ_1 :

$$\begin{aligned} \varepsilon &= \frac{2\pi(r_A + s + u) - 2\pi(r_A + s)}{2\pi(r_A + s)} = \\ &= \frac{u}{r_A + s} = \frac{u_B s}{2(a+h)(r_A + s)} \end{aligned} \quad (10)$$

where r_A – is the radius of the circle of the torus that passes through the point "A" (along this radius, the camera is attached to the platform). The stress in the cross-section of the chamber will be σ_1 :

$$\sigma_1 = \varepsilon E = \frac{u_B s}{2(a+h)(r_A + s)} E \quad (11)$$

where E – is the modulus of elasticity of the chamber material. The variables x_1 and x_2 can be expressed in terms of the displacement variable s , namely:

$$\begin{aligned} x_1 &= -a-h+s; \quad h \leq s \leq 2(a+h)-h; \\ x_2 &= -a-h+s; \quad 0 \leq s \leq 2(a+h). \end{aligned} \quad (12)$$

We substitute expression (11) for stresses into equation (8). At the same time, we consider that the stress distribution is symmetrical concerning the Ox axis, and then we replace the double integral with three single integrals (13):

$$p\pi ab = \frac{u_B E}{a+h} \left(\int_0^h \frac{h s y_2(s) ds}{r_A + s} + \int_h^{2a+h} \frac{s(y_2(s) - y_1(s)) ds}{r_A + s} + \int_{2a+h}^{2(a+h)} \frac{2(a+h) s y_2(s) ds}{r_A + s} \right) \quad (13)$$

$$\begin{aligned} \text{where: } y_1(s) &= b \sqrt{1 - \frac{(s-a-h)^2}{a^2}}; \\ y_2(s) &= (b+H) \sqrt{1 - \frac{(s-a-h)^2}{(a+h)^2}}. \end{aligned}$$

For the convenience of calculations, we make a change of variables in the integrals: $s = (a+h)z; 0 \leq z \leq 2; ds = (a+h)dz$ and denote $k = h/(a+h), n = ra/(a+h)$.

Then equality (13) can be written as

$$p\pi ab = u_B E (b+H) \cdot J \quad (14)$$

where:

$$\begin{aligned} J &= \int_0^2 z \sqrt{1 - (1-z)^2} \frac{dz}{n+z} - \\ &- \frac{b}{b+H} \int_k^{2-k} \sqrt{1 - \frac{(a+h)^2}{a^2} (1-z)^2} \frac{z dz}{n+z} \end{aligned}$$

From equality (14), we find the displacement u_B of point B (see Figure 7), and then using formula (11), we can determine the distribution of stresses in the cross-section of the chamber

$$u_B = \frac{p\pi ab}{E(b+H) \cdot J} \quad (15)$$

To find the stresses perpendicular to the stresses σ_1 , we conditionally cut an elementary (small) surface from the chamber shell, apply pressure "p", stress σ_1 , σ_2 to it, and compose an equilibrium equation in projection onto the normal to this surface. As a result, we get the equality:

$$\frac{\sigma_1}{r_A + s} + \frac{\sigma_2}{\rho(x_2)} = \frac{p}{h(x_2)} \quad (16)$$

where: $h(x_2)$ – shell thickness; $h \leq h(x_2) \leq H$ $\rho(x_2)$ is the radius of curvature of the section, which is found on the basis of equation (7).

From equation (7), we have:

$$x_2 = (a+h) \sqrt{1 - \frac{y_2^2}{(b+H)^2}};$$

$$\frac{dx_2}{dy_2} = -\frac{a+h}{(b+H)^2} y_2 \left(1 - \frac{y_2^2}{(b+H)^2}\right)^{-0.5}.$$

We introduce the notation

$$K = \frac{d^2 x_2}{dy_2^2} = -\frac{a+h}{(b+H)^2} \left(\left(1 - \frac{y_2^2}{(b+H)^2}\right)^{-0.5} + \frac{y_2^2}{(b+H)^2} \left(1 - \frac{y_2^2}{(b+H)^2}\right)^{-1.5} \right).$$

Then we write: $\rho(x_2) = \frac{1}{|K|}$. In particular, for points

$$\text{A or "B": } \rho(x_2) = \frac{(b+H)^2}{a+h}.$$

From equation (16), we obtain the following expression:

$$\sigma_2 = \rho(x_2) \left(\frac{p}{h(x_2)} - \frac{\sigma_1}{r_A + s} \right) \quad (17)$$

In particular, for point "B" (see Figure 7):

$$\sigma_2 = \frac{(b+H)^2}{a+h} \left(\frac{p}{h} - \frac{\sigma_1}{r_A + 2(a+h)} \right).$$

It is known that the strength condition, according to the classical fourth (energy) theory of strength, has the form

$$sgm = \sqrt{\sigma_1^2 + \sigma_2^2} - \sigma_1 \sigma_2 \leq \sigma_p \quad (18)$$

Let us assume that at some pressure, the point "B" of the chamber moves by the amount $(ub)_2$ and touches the pipe's walls of radius r_2 . A band of contact between the chamber and the pipeline walls is formed with further

pressure increases. Let the width of the contact strip at pressure be $2s$. Then the width of the contact strip can be found based on the equation (7) of the ellipse:

$$c = (b+H) \sqrt{1 - \frac{(a+h-\Delta)^2}{(a+h)^2}} \quad (19)$$

where $\Delta = (uB)_3 - (uB)_2$. The distribution of pressure on the contact zone of the chamber with the pipeline can be described by the formula:

$$p_4(s_1) = (p_3 - p_2) \left(1 - \frac{s_1^2}{c^2} \right); \quad -c \leq s_1 \leq c \quad (20)$$

We find the total normal reaction (see Figure 1):

$$N = 2\pi r_2 (p_3 - p_2) \int_{-c}^c \left(1 - \frac{s_1^2}{c^2} \right) ds_1 =$$

$$= \frac{8}{3} \pi r_2 (p_3 - p_2) c. \quad (21)$$

Both module chambers can be fixed when the module performs a technological operation: upper and lower, for more reliable module retention in the pipeline. Then we will determine by formula (21) the normal reactions N_1 and N_2 . Then we will find the permissible value of the technological force Q , which is required for the reliable operation of the technical module:

$$Q \leq f(N_1 + N_2) - (m_1 + m_2)g \quad (22)$$

where f – is the sliding friction coefficient of the chamber material against the pipeline wall.

As an example of modeling displacement and calculating the equivalent stress, below are graphs of these parameters. Calculations were performed with the following values of constant chamber dimensions (see Figure 7): $a=0.04\text{m}$; $b=0.05\text{m}$; $H=0.002\text{m}$; $h=0.001\text{m}$; $r_a=0.3\text{m}$. Engineers can arbitrarily change these design parameters depending on the design tasks. Figure 8 shows a graph of the movement of the points of the chamber section depending on the pressure in the elastic chamber of the module.

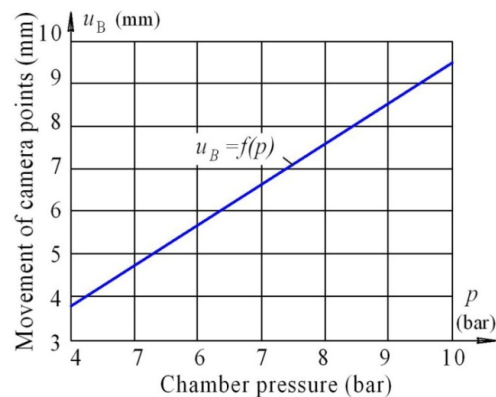

Figure 8. Moving point "B" of the camera section (see Figure 7) in the radial direction depending on chamber pressure

This schedule is necessary for programming the change in pressure in the elastic chambers to securely

hold the module in the pipeline that it serves. As shown in Figure 8, the function $uB=f(p)$ is linear, making it possible to apply the method of linear programming of pressure in elastic chambers and thereby reduce the cost of control equipment.

Figure 9 shows the dependence of the equivalent stress, which determines the elastic chambers' strength on the pressure in these chambers. The equivalent voltage is calculated by the formula (18). This diagram is recommended for engineers to ensure the reliable operation of the processing module. In this case, the module's weight was $m=m1+m2=40+40=80(\text{kg})$, and polyvinyl chloride (PVC) was chosen as the chamber material, with relatively high strength.

The calculations were performed with the following parameter values (see Figure 7): $a=0.04\text{m}$; $b=0.05\text{m}$; $H=0.002\text{m}$; $h=0.001\text{m}$; $r_a=0.3\text{m}$. Of course, other characteristics of the materials should be considered if they differ from those indicated above, including the ratio of parameters indicated in Figure 7.

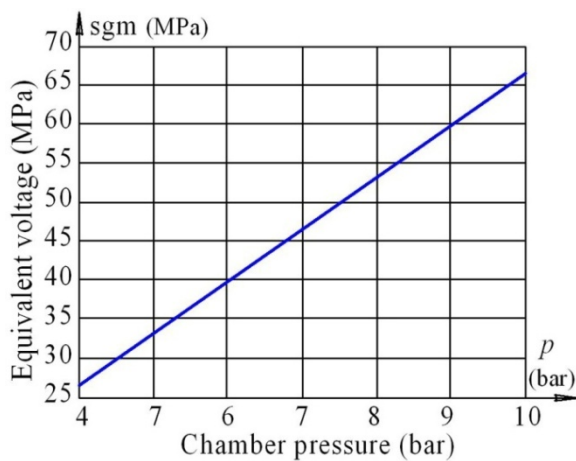

Figure 9. Values of the equivalent voltage, which is determined by the formula (18), depend on the pressure in the chamber

5. RESULTS AND DISCUSSION

Unlike the technical solutions for pipeline maintenance considered in section 2, the proposed technological module can adapt to various diameters of pipelines, including conical pipelines. The presence of a spherical swivel (see Figure 1) in the module's design allows its platforms to be located at an arbitrary angle relative to each other. Such a need arises in cases of bends in pipelines or the location of individual pipeline sections at an angle close to each other.

As can be seen from the graphs in Figure 4 and Figure 5, the technological module has a relatively high speed of movement when servicing the internal surfaces of pipelines. The equivalent stress curves (see Figure 9) indicate that these chambers have a reasonably high strength even at high pressures in the elastic chambers. In this case, polyvinyl chloride (PVC) was used as the chamber material. However, this material property is not a limitation. Other elastic materials for the module chambers can also be successfully used. But the strength limit of these materials must be in the ranges of tensile forces of $4 \cdot 10^7 \dots 7 \cdot 10^7$ (Pa), and in bending, the stren-

gth is not less than values in the field of $8 \cdot 10^7 \dots 12 \cdot 10^7$ (Pa). The ranges of the specified strength values will ensure the reliable operation of the module.

The technological purpose of the module determines the choice of the pneumatic or hydraulic drive. It is recommended to use a pneumatic drive for modules that perform light duty operations, such as diagnostics or video surveillance of the internal surfaces of pipelines. Hydraulic drive is recommended when performing power operations, such as cleaning or mechanical processing of pipeline surfaces.

6. CONCLUSION

In this article, the authors proposed a fundamentally new design of a mobile technological module for servicing the internal surfaces of industrial pipelines. The main difference between the proposed module is the presence of elastic chambers, which allow periodic fixation of the module on the walls of pipelines under the pressure of compressed air or liquid under pressure. The presence of elastic chambers ensures the adaptation of the module to any topology of industrial pipelines. Using a diaphragm drive and elastic elements allows the module to achieve a relatively high movement speed from 2m/s to 3.5m/s when moving inside the pipeline. The proposed analytical and graphical dependences of the design parameters of the module allow researchers and engineers in this field to carry out the multivariate design of such devices. The simulation results of this technological module illustrate its industrial feasibility in servicing pipelines for various purposes.

Ultimately, the proposed technological module can overcome the gravitational load when servicing vertical pipelines with different diameters and shapes. The main result of these studies is to reduce the cost of preventive maintenance of pipelines by eliminating the need for their dismantling and the possibility of the module functioning in stand-alone mode.

DECLARATION OF CONFLICTING INTERESTS

The author(s) declared no potential conflicts of interest with respect to the research, authorship, and/or publication of this article.

REFERENCES

- [1] Johann Borenstein, Geoffrey A. Long, Mariya Del Rey. Apparatus for obstacle traversal. Patent US № 6512345 Int. CI. B08B9/045. Filed: Mar. 30, 2001; Date of Patent: Jan. 28, 2003.
- [2] Johann Borenstein. Apparatus for obstacle traversal. Patent US № 6774597 Int. CI. B08B9/045. Filed: Dec. 12, 2002; Date of Patent: Aug. 10, 2004.
- [3] G. Granosik, M. G. Hansen, J. Borenstein. The Omni Tread Serpentine Robot for Industrial Inspection and Surveillance. International Journal on Industrial Robots, Special Issue on Mobile Robots, vol. IR32-2, March 18th, 2005, p. 139-148.
- [4] Skvortsov V.E. Skvortsov M.V. Autonomous for inside the pipe transport device. Patent RU 2509255

Int. CI. F16L 55/34. Filed: 11/14/2012; published 03/10/2014.

- [5] Sinev A.V., Gradetsky V.G., Kravchuk L.N. et al. Vehicle for Movement in various kinds of soil "worm". Patent RU 2260542 IPC B62D57/032. Filed: 03/12/2003; publ. 09/20/2005.
- [6] Sinev A.V., Gradetsky V.G. Kravchuk L.N. et al. Transport device for inside the pipe. Patent RU 46986 for utility model Int. CI. B62D57/032. Filed: 03/12/2003; publ. 08/10/2005. Bull. No. 22.
- [7] Miroslava Ľavodová, Nataša Náprstková, Michaela Hnilicová, Pavel Beňo (2020). Quality Evaluation of Welding Joints by Different Methods. FME Transactions, Vol. 48, No 4, 2020, pp. 816-824.
- [8] Djarot B. Darmadi. Incorporating Aged Martensite Model in Residual Stress Prediction of Ferritic Steels Girth Weld. FME Transactions. Vol. 47, No 4, 2019, pp. 901-913.
- [9] Tiehua Hu, Jingbo Guo. Development and application of new technologies and equipment for in-line pipeline inspection. Natural Gas Industry B, Volume 6, Issue 4, 2019, Pages 404-411, ISSN 2352-8540.
- [10] Polishchuk, M., Suyazov, M., Opashnyansky, M. Study on numerical analysis of dynamic parameters of mobile walking robot. Journal of Mechanical Engineering and Sciences, 2020, 14(1), pp. 6380-6392.
- [11] Polishchuk, M., Tkach, M. Mobile robot with an anthropomorphic walking device: Design and simulation. FME Transactions, 2020, Vol. 48, No. 1, pp. 13-20.
- [12] Kornienko, Y.M., Liubeka, A.M., Sachok, R.V., Korniyenko, B.Y. Modeling of heat exchangement in fluidized bed with mechanical liquid distribution (2019) ARPN Journal of Engineering and Applied Sciences, 14 (12), pp. 2203-2210.
- [13] Robot for diagnostics and cleaning of pipelines Jetty Robot. Internet resource. URL:
- [14] <https://www.jettyrobot.com/> (date of the application 20.02.2022).
- [15] Kurylovych, V., Kravchuk, A., Melnychuk, P., Mohelnytska, L. Automated Attestation of Metrics for Industrial Robots' Manipulation

Systems. Lecture Notes in Mechanical Engineering, 2021, pp. 813-822.

- [16] Hutyria, S., Chanchin, A., Yahlinskyi, V., Khomiak, Y., Popov, V. Evolution of trolley-bus: Directions, indicators, trends. Diagnostyka, 2020, 21(1), pp. 11-26.
- [17] Transport device for moving inside pipes: Patent UA 118921. Int. CI. F16L 55/34. Filed: Oct. 24.2017. Date of Patent: Mar. 25.2019. Bull. No. 6.

МОДУЛ МОБИЛНЕ ТЕХНОЛОГИЈЕ ЗА ОДРЖАВАЊЕ ЦЕВОВОДА: ПРОЈЕКТОВАЊЕ И СИМУЛАЦИЈА

М. Полишчук, В. Јалински

Савремене цевоводне комуникације захтевају периодично одржавање за различите намене, као што су цеви за гас, нафту, водоводне станице, димњаци и други цевоводи. Такво одржавање подразумева транспортне уређаје који раде аутономно унутар цевовода, укључујући и вертикалне цеви, и обављају различите технолошке операције, као што су дијагностиковање унут-рашњег стања цеви, њихово чишћење, наношење заштитних премаза, машинска обрада, заваривање и сл.

У чланку се предлаже фундаментално нови дизајн мобилног технолошког модула за сервисирање унутрашњих површина цевовода. Главна предност предложеног модула је његова способност да се креће дуж вертикалних цевовода различитих пречника уз савладавање гравитационог оптерећења. Овај ефекат се постиже коришћењем еластичних комора у дизајну модула. Када им се доводе компримовани ваздух или течност под притиском, они периодично причвршћују модул на унутрашње површине цевовода. Основни економски ефекат је смањење трошкова превентивног одржавања ради одржавања унутрашњих површина вертикалних цевовода, односно без њиховог демонтаже и уз истовремену могућност прилагођавања транспортних уређаја топологији цевовода. У чланку је дат опис новог дизајна технолошког модула и аналитичких зависности за прорачун пројектних параметара модула. Приказани су резултати моделирања параметара модула.