

Miloš Vorkapić

Associate Research Professor
University of Belgrade
Institute of Chemistry, Technology and
Metallurgy

Danijela Živojinović

Professor
Academy of Applied Vocational Studies
Belgrade

Dragan Kreculj

Senior lecturer
Academy of Applied Vocational Studies
Belgrade

Toni Ivanov

Assistant Professor
University of Belgrade
Faculty of Mechanical Engineering

Marija Baltić

Assistant Research Professor
University of Belgrade
Faculty of Mechanical Engineering

Aleksandar Simonović

Full Professor
University of Belgrade
Faculty of Mechanical Engineering

Application of Additive Technology and Reverse Engineering in the Realization of Damaged Obsolete Parts

Reverse engineering (RE) aims to design a new replacement part based on the existing part. The goal is to perform a quality reproduction of the physical part with the best possible mechanical characteristics aiming to find optimal solutions regarding the shape and dimensions of the part. The procedure is implemented through a series of steps: creating a digital 3D model, improving model parameters, and realizing products using additive technologies. In this paper, a review and implementation of the fundamental methodologies of RE were carried out on the example of a damaged protective cover with an unknown geometry and material essential for the function of a discontinued device with no technical documentation and spare parts. An optical scanning method, 3D CAD, FEA, and additive manufacturing were used to realize the reproduced part. It was shown that by utilizing RE the lifecycle of the device could be significantly extended with minimal cost.

Keywords: 3D scanning, additive technology, FDM process, reverse engineering, FEA, model manufacturing.

1. INTRODUCTION

Reverse engineering (RE) is a method that applies modern theoretical design methods, elements of production engineering, materials science, and related professional knowledge [1].

Based on the existing model, RE enables refinements, modifications, and application of new ideas and technologies in solving problems of new or improved design [2].

In this direction, there is also a reduction in certain steps in the product development process [3]. The Japanese mostly used RE to improve products compared to competitors and successfully managed to avoid obstacles and reduce efforts in the realization of a new or original design [4].

RE does not serve to copy an existing product, but its primary purpose is the realization of a digital product model and further improvement and optimization of parameters. The biggest challenge in the application of RE is the high-quality reproduction of the physical part with the best possible characteristics while keeping the implementation costs as low as possible. Namely, the basic information about the material (its chemical composition) still needs to be discovered because the design is primarily considered, giving designers the space to find optimal solutions in defining the new product.

In general, every product has its life cycle. RE is a process that helps manufacturers shorten the time to market. According to Kroma et al. [5], product

maintenance and product servicing are covered by spare parts. Unfortunately, due to a more demanding market, primary (leading) product manufacturers disappear or change their production programs. This entails the interruption of production of both the primary product (obsolete or in the phase of shutdown) and the range of spare parts.

RE can also represent a company's strategic decision, primarily due to the reduction of competitiveness and the time required to create a prototype [6]. The combination of various methods and technologies in the redefinition of product design data enables rapid reconstruction, modification, or realization of a new design with the rapid elimination of critical factors and positions [7].

A CAD model based on a scan of an existing part or assembly is obtained through RE. The procedure is very suitable in cases where there is only a physical part or a finished product without any technical documentation (drawings, details, sketches) or where the technical documentation needs to be digitized (handmade products or unique items) [5, 8-10]. RE is widely used in industry (related to industrial design) and in various handmade activities (producing jewelry, molds and tools, and antiques). It is also used to reconstruct parts and tools [11,12] and to service defective devices [10].

RE has become a reliable tool in the digital-physical process of designing elements and assemblies with a significant application in the automotive [13] and aerospace industries [14]. Namely, when a car is launched on the market, competitors immediately buy the car, disassemble it and scan the parts to learn as much as possible about the structural elements, their geometry, and the functional connections between the parts.

The RE working process (or block diagram) is given in Figure 1. The main stages of the RE process consist

Received: December 2023, Accepted: January 2023

Correspondence to: Miloš Vorkapić, University of Belgrade, Institute of Chemistry, Technology and Metallurgy, 11000 Belgrade, Njegoševa 12, Serbia.

E-mail: worcky@nanosys.ihtm.bg.ac.rs

doi: 10.5937/fme2301031V

© Faculty of Mechanical Engineering, Belgrade. All rights reserved

FME Transactions (2023) 51, 31-38 31

of the following steps: a) collection and processing of source data based on the existing physical model; b) digitalization of the model with the formation of a cloud/network of points; c) data analysis and specifying regions for modification with CAD model design or reconstruction); d) new model production process; e) realized prototype (additional analysis of geometry and mechanical characteristics) [15-16].

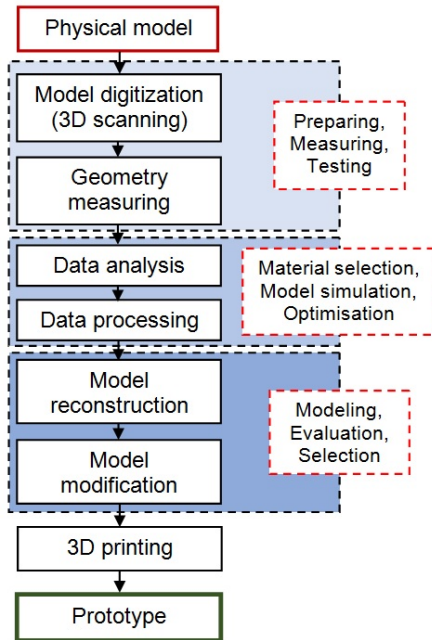

Figure 1. RE working processes

2. 3D SCANNING

Scanning represents the model reconstruction technology in which a digital model of the physical part is created. The scanned part represents a covered geometric contour filled with lines or scanning grid points. This point structure is then parameterized and further processed using 3D CAD software to create a solid 3D model of the part [17].

Methodologically the RE process is divided into three primary operations [12, 18-21].

1. 3D geometry digitalization. This operation involves receiving numerous coordinates of points on the surfaces of the scanned parts. Scanning of objects is done from different sides and can be manual or automated. A non-contact 3D optical system is often used for this operation.
2. Processing of measured data. From the point cloud data, a triangular mesh is obtained. In order to remove irregularities and increase accuracy, digital filters and additional data about the scanned object are used. The process of optimization and segmentation can improve the quality of the mesh representation of the object.
3. We are creating a CAD model. The mesh representation of the model is effectively handled in the CAD environment and redesigned in a parametric or vectorized model.

By applying RE, three-dimensional models can be recorded quickly in digital form and modeled again, and after that, a prototype can be quickly made.

3. REVERSE ENGINEERING TECHNOLOGY

3.1 Model description

The RE technique applied to the redesign of an existing plastic physical part that could not be commercially obtained is shown in this paper. During the long-term exploitation of the Micro Automation (model 602) machine for cutting silicon wafers, a fracture occurred on the protective cover of the cutting section of the device, see Figure 2.



Figure 2. Micro Automation device for cutting silicon wafers (left) with a fractured protective cover (right)

Unfortunately, since it is an old and technologically outdated machine, no spare parts can be obtained by the manufacturer. The only technical documentation besides the manual for device handling in a printed edition (Manual - 602M Dicing Saw Operation Manual, 1983) could not be obtained. Physical measurements of the specimen were made before scanning. Only a simplified assembly sketch of the cutting mechanism was given in the manual with the parts shown in Figure 3:

1. device;
2. dicing blade;
3. shaft nut and teflon spacer;
4. cover;
5. working surface;
6. splash protection mask.

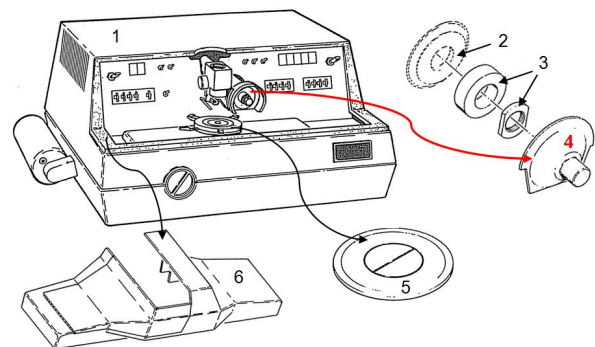

Figure 3. Wafer cutting mechanism

The protective cover's function is to enable uniform distribution of the coolant to the cutting saw during operation. Also, it protects the operator from mishandling and eventual debris due to wafer breakage during cutting. The cover directs the coolant and prevents it from spreading beyond the defined boundaries.

Within the available instructions, there is no information on the pressure value of the coolant.

The impact of the water jet caused damage (fracture) to the cover. In order to ensure the proper device functioning, the new cover manufacturing was started using additive technologies.

ximum Von Mises stresses for both models were calculated as follows:

$$\sigma_{\max} = 126.4 \text{ MPa (Model 1) and}$$

$$\sigma_{\max} = 84.6 \text{ MPa (Model 2)}$$

respectively. As expected, the maximum stress values occur in the grooves where the part is fixed, i.e., the displacement constraints, see Figure 8. The distribution of *Von Mises* stresses in the structure and deformations of the structure itself are shown in Figures 8 and 9.

It was found that by increasing the diameter of the grooves, a stress reduction of about 33% can be achieved.

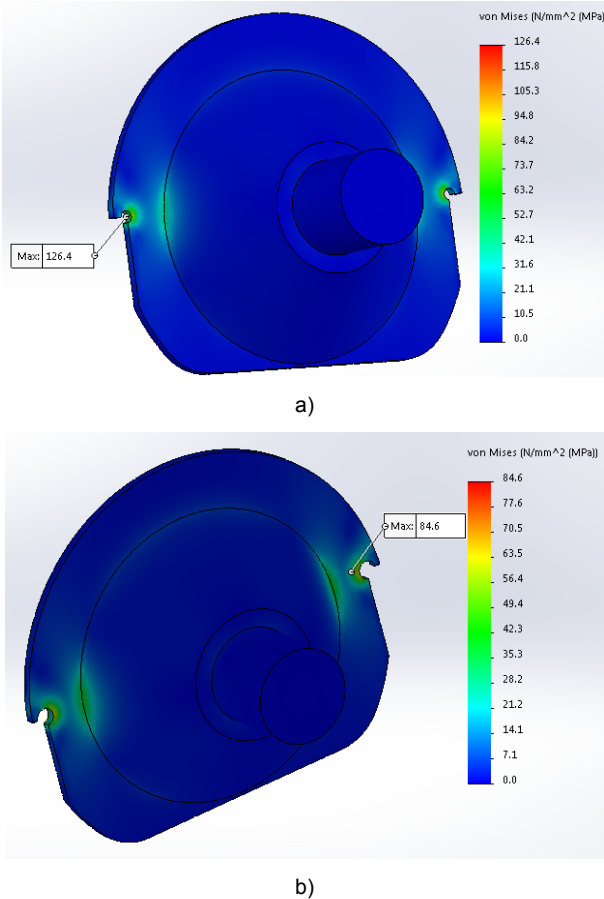

Figure 8. Von Mises stress distribution p = 500 mbar: a), Model 1, b) Model 2

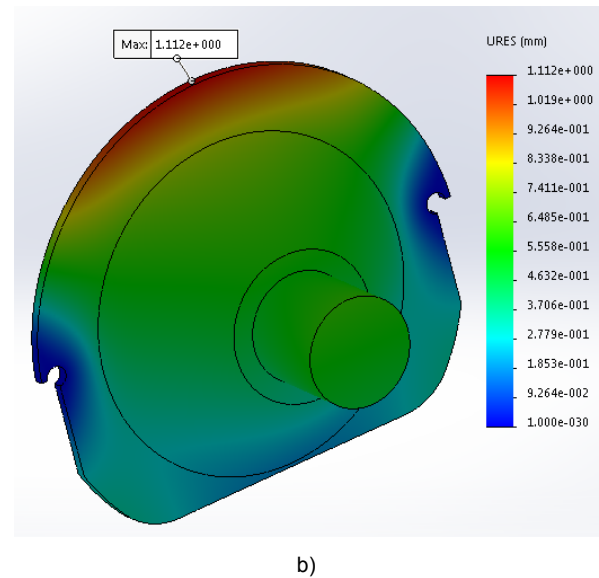
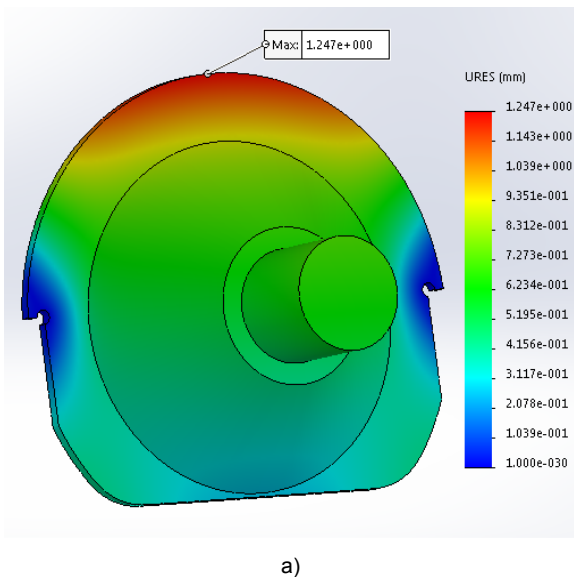

Figure 9. Deformation distributions in the structure (Model 1) at p=500mbar

For the manufacturing of a part, three different materials most often used in FFF (Fused Filament Fabrication) were considered: ABS (Acrylonitrile Butadiene Styrene), PLA (Polylactic Acid), and PETG (Polyethylene Terephthalate Glycol) [23]. The mechanical properties of the mentioned materials are given in table 1.

Table 1. Mechanical properties of the tested materials [24]

Material	Tensile strength $\sigma_{\max} = \sigma_m$ [MPa]	Yang's modulus E [MPa]	Poisson's coeff. ν [-]
ABS	33.24	2000	0.394
PLA	46.37	2000	0.394
PETG	45.75	2000	0.394

The maximum stress value ($\sigma_{\max} = \sigma_m$), which the given material can withstand, was adopted as the calculation criterion. Of the materials mentioned above, ABS is the minor quality of the material's mechanical properties. If the value $S=1.5$ is adopted for the safety coefficient, the following value is obtained for the allowable stress in the structure:

$$\sigma_{\text{doz}} = \frac{\sigma_m}{S} = \frac{33.24 \text{ MPa}}{1.5} = 22.16 \text{ MPa}$$

A series of calculations were performed for different pressure values to determine the maximum allowed working pressure. The maximum values of Von Mises stress in part manufactured with ABS as a function of pressure were obtained (see table 2).

Table 2. Values of the maximum Von Mises stress in part depending on the pressure

Pressure (load) p [mbar]/[MPa]	Max. <i>Von Mises</i> -ov stress σ_{\max} [MPa]
100/0.0100	18.0
120/0.0120	21.6
122/0.0122	21.9
123/0.0123	22.1

Based on the data in table 2, the pressure value $p=123\text{mbar}=0.0123\text{MPa}$ shown indicates that the construction made by 3D printing from ABS material can maintain its integrity, see Figures 10 and 11.

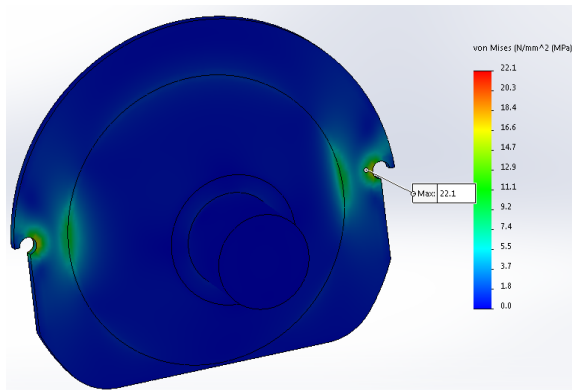

Figure 10. Von Mises stress distribution in part at $p = 0.0123\text{MPa}$

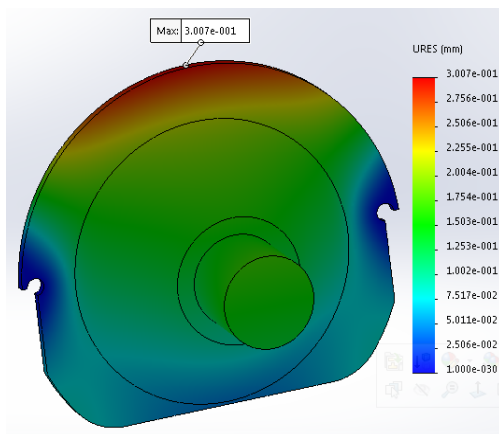

Figure 11. Deformation distribution in the structure at $p = 0.0123\text{MPa}$

If during 3D printing, other materials, such as PLA or PETG, are used for the production of the part, the safety coefficient is higher and amounts to the next values:

$$\text{For PLA: } S = \frac{\sigma_m}{\sigma_{\max}} = \frac{46.37 \text{ MPa}}{22.1 \text{ MPa}} = 2.10.$$

$$\text{For PETG: } S = \frac{\sigma_m}{\sigma_{\max}} = \frac{45.75 \text{ MPa}}{22.1 \text{ MPa}} = 2.07.$$

3.4 FDM procedure in new model realization

Before scanning, the dimensions of the broken part were taken by manual measurement using a caliper. This procedure determines the exact measurements of diameter, length, depth, and height. However, collecting measurements requires considerable effort and much practice for complex objects and surfaces. In general, manual measurement technology is simple but presents a problem when the subject is more complex [25].

The FDM process (or 3D printing) plays a significant role in model making. It is an additive technology in which a 3D object is formed layer by layer with the help of a thermoplastic filament [26].

For 3D printing, a CAD model processed in an (STL) format is used. A slicer software then uses the *stl file and some defined parameters, such as print

speed, layer height, etc., to generate a *gcod. This *gcod is used by the 3D printer to produce the finished model/prototype. The Ultimaker Cura V. 4.3.0 was used to generate the *gcod file [27 - 29].

Unfortunately, when using FFF/FDM compared to other technologies, the reproduced models have poor dimensional accuracy and bad surface quality [30].

In addition, the key factors that affect the quality of FDM technology are shrinkage of material, thickness, and accuracy of material printing by layers [31].

Figure 12 shows the transformation procedure *stl files in recognizable *gcod for printer operation and a display of FDM printer head operation based on given parameters.

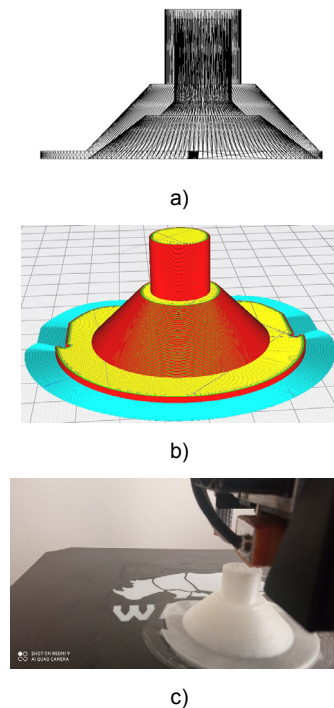

Figure 12. 3D Cover realization: a) *stl file, b) Cura program (*gcod file), c) model manufacturing

A 3D printer Wanhao Duplicator, type i3 plus, was used in the realization of the protective cover. The printer has a working volume of $200 \times 200 \times 180\text{mm}$, layer printing resolution $> 0.1\text{mm}$, 0.4mm nozzle diameter, and a printing speed of $10\text{-}100\text{mm/s}$. Acrylonitrile Butadiene Styrene (ABS) filament with a diameter of 1.75 mm (manufactured by Verbatim) was used in the model realization.

The set printing parameters are given in table 3.

Table 3. Basic model parameters

Parameter	Value
Layer height	0,1 mm
Wall thickness	0,8 mm
Top thickness	0,8 mm
Infill density	100%
Infill pattern	Grid
Printing temperature	230°C
Build plate temperature	70°C
Print speed	60 mm/s
Support pattern	Zig Zag
Support Density	15%
Buil plate Adhesion Type	Brim

According to Lim et al. [32], ABS is an amorphous polymer characterized by the following parameters: excellent mechanical properties, resistance to elevated temperatures, and impact resistance. ABS is resistant to dilute acids, concentrated hydrochloric and phosphoric acids, alcohols, and fats [33].

3.5 Additional processing of the prototype

After the printing, additional processing of the finished model is started. Figure 13 shows the additional processing procedure and the realized model appearance of the protective cover during different phases. The mechanical cover treatment was carried out using three different sandpapers (P100, P180, and P320) with constant water cooling. The cooling process was necessary to prevent the plastic mass's heating and melting, see Figure 13a).

The sandpaper was used to remove significant irregularities and excess material. After the visual inspection, the dimensions were checked, and the process of grouting and obtaining smooth surfaces for painting was started. In the end, P600 sandpaper was used (see picture 13b). The protective cover was finally painted and mounted on the device (see pictures 13c and 13d).

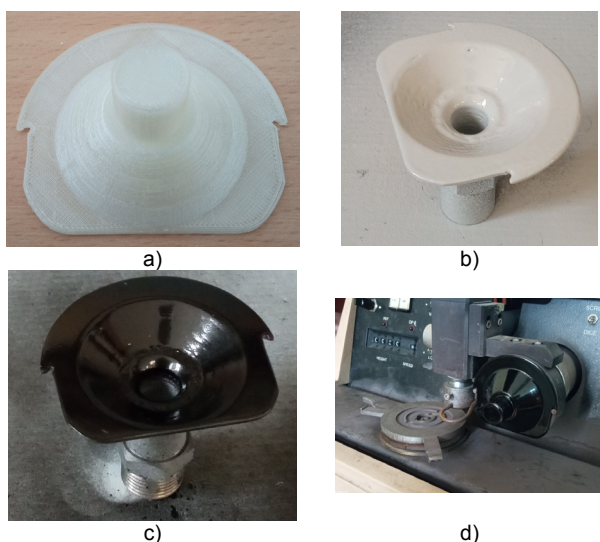

Figure 13. Additional processing: a) sandpaper processing, b) grouting process, c) painting process and d) assembling

4. CONCLUSION

When servicing machines, minor or permanent damage must be recorded and dealt with. Every failure affects the manufacturing process and supply chain; consequently, financial losses are inevitable. Mechanical stress usually results in abrasion or damage. If it is a question of designers' mistakes (poor materials selection and weak construction solutions), then cracks or breakage may occur due to the effect of static loading (less often), namely due to the effect of dynamic loading (i.e., fatigue of materials), which is the more common case in industrial practice.

When the original model cannot provide enough engineering information regarding materials and permitted tolerances, the application of RE is of great importance in realizing a replacement part.

This paper shows the implementation of RE in a case when the device manufacturer cannot supply a spare part because the device is considered outdated and is no longer produced. Applying new computer technologies reduces the time required to produce spare/repared or new parts. New 3D scanning and 3D printing techniques enable fast processing and model realization. Here, by applying the mentioned techniques, a protective cover satisfying the loading criteria was produced, further extending the lifecycle of the Micro Automation device for cutting silicon wafers.

Different 3D techniques and materials can provide different manufacturing possibilities, and their application in RE should be further researched. The progress yet to be achieved in recyclable and biodegradable polymers opens the possibility of replacing parts manufactured with not-so-environmentally friendly materials (with similar mechanical characteristics).

ACKNOWLEDGEMENTS

This work was funded by the Ministry of Education, Science and Technological Development of the Republic of Serbia, Grants No. 451-03-68/2022-14/200026 and 451-03-68/2022-14/200105.

REFERENCES

- [1] Zhang, J., Yu, Z.: Overview of 3D printing technologies for reverse engineering product design, *Automatic Control and Computer Sciences*, Vol. 50, No. 2, pp. 91-97, 2016.
- [2] Iyer, N, Kalyanaraman, Y., Lou, K., Janyanti, S., Ramani, K.: A reconfigurable 3D engineering shape search system: Part I- Shape representation, in: *International Design Engineering Technical Conferences and Computers and Information in Engineering Conference*, pp. 89-98, 2003.
- [3] Zhang, Y.: Research into the engineering application of reverse engineering technology, *Journal of Materials Processing Technology*, Vol. 139, No. 1-3, pp. 472-475, 2003.
- [4] Onuh, S., Bennett, N. and Hughes, V.: Reverse engineering and rapid tooling as enablers of agile manufacturing, *International Journal of Agile Systems and Management*, Vol. 1, No. 1, pp. 60-72, 2006.
- [5] Kroma, A., Adamczak, O., Sika, R., Górski, F., Kuczko, W., Grześkowiak, K.: Modern Reverse Engineering Methods Used to Modification of Jewelry, *Advances in Science and Technology. Research Journal*, Vol. 14, No. 4, pp. 298-306, 2020.
- [6] Dúbravčík, M., Kender, Š.: Application of reverse engineering techniques in mechanics system services, *Procedia Engineering*, Vol. 48, pp. 96-104, 2012.
- [7] Babić, M., Verić, O., Božić, Ž., Sušić, A.: Fracture analysis of a total hip prosthesis based on reverse engineering, *Engineering Fracture Mechanics*, Vol. 215, pp. 261-271, 2019.

- [8] Raja, V., Fernandes, K. J. (Eds.). (2007). *Reverse engineering: an industrial perspective*. Springer Science & Business Media.
- [9] Wang, W.: *Reverse engineering: Technology of reinvention*, Crc Press, 2010.
- [10] Vozisova, O., Eroshenko, S., Koksharova, E., Khalyasmaa, A., Dmitriev, S. (2016, March). Application of 3D scanning and printing technologies in Electric power industry. In *2016 IEEE International Conference on Industrial Technology (ICIT)* (pp. 892-897). IEEE.
- [11] Sokovic, M., Kopac, J.: RE (reverse engineering) as necessary phase by rapid product development, *Journal of Materials Processing Technology*, Vol. 175, No. 1-3, pp. 398-403, 2006.
- [12] Morovic, L.: *Rapid technologie. Rapid Technologies. Automation and CA Systems in Technology Planning and Manufacturings*. Poznae University of Technology, pp. 177-183, 2004.
- [13] Raja, V., Fernandes, K. J.: *Reverse engineering: an industrial perspective*, Springer Science & Business Media, in: *Advanced Manufacturing Publisher: Springer*, 2007.
- [14] Fu, P.: *Reverse engineering in the aerospace industry*, in: *Reverse Engineering*, Springer, London, pp. 157-175, 2008.
- [15] Zhang, Y.: *Research into the engineering application of reverse engineering technology*, *Journal of Materials Processing Technology*, Vo.: 139, No. 1-3, pp. 472-475, 2003.
- [16] Li, L., Schemenauer, N., Peng, X., Zeng, Y., Gu, P.: *A reverse engineering system for rapid manufacturing of complex objects*, *Robotics and Computer-Integrated Manufacturing*, Vol. 18, No. 1, pp. 53-67, 2002.
- [17] Che, J., Zhang, Y., Wang, H., Liu, Y., Du, M., Ma, S., Suo, C.: *A novel method for analyzing working performance of milling tools based on reverse engineering*, *Journal of Petroleum Science and Engineering*, Vol. 197, pp. 107987, 2021.
- [18] Zhang, Y.: *Research into the engineering application of reverse engineering technology*, *Journal of Materials Processing Technology*, Vol. 139, No. 1-3, pp. 472-475, 2003.
- [19] Buonamici, F. et al.: *Reverse engineering modeling methods and tools: a survey*, *Computer-Aided Design and Applications*, Vol. 15, No. 3, pp. 443-464, 2018.
- [20] Onuh, S., Bennett, N. Hughes, V.: *Reverse engineering and rapid tooling as enablers of agile manufacturing*, *International Journal of Agile Systems and Management*, Vol. 1, No. 1, pp. 60-72, 2006.
- [21] Bradley, C., Currie, B.: *Advances in the field of reverse engineering*, *Computer-Aided Design and Applications*, Vol. 2, No. 5, pp. 697-706, 2005.
- [22] Rysinski, J., Wrobel, I.: *Diagnostics of machine parts by means of reverse engineering procedures*, *Advances in Mechanical Engineering*, Vol. 7, No. 5, pp.1-9, 2015.
- [23] Pavlović, A., Šljivić, M., Krajsnik, M., Ilić, J., Anić, J.: *Polymers in additive manufacturing: The case of a water pump impeller*, *FME Transactions*, Vol 45, No. 3, pp. 354-359, 2017.
- [24] Hasan, M., S., Ivanov, T., Tanović, D., Simonović, A., Vorkapić, M.: *Dimensional accuracy and experimental investigation on tensile behavior of various 3D printed materials*, in: *9th International scientific conference on defensive tehnologies, OTEH 2020*, Belgrade, pp. 400-406, 2020.
- [25] Campbell, R.J., Flynn, P.J.: *A survey of free-form object representation and recognition techniques*, *Comput Vision Image Understanding*, Vol. 81, No. 2, pp. 166-210, 2001.
- [26] Bin Ishak, I., Fleming, D. and Larochelle, P.: *Multiplane fused deposition modeling: a study of tensile strength*, *Mechanics Based Design of Structures and Machines*, Vol. 47, No. 5, pp. 583-598, 2019.
- [27] Wang, P., Yang, J., Hu, Y., Huo, J., Feng, X.: *Innovative design of a helmet based on reverse engineering and 3D printing*, *Alexandria Engineering Journal*, Vol. 60, No. 3, pp. 3445-3453, 2021.
- [28] Živanović, S. T., Popović, M. D., Vorkapić, N. M., Pjević, M. D., Slavković, N. R.: *An overview of rapid prototyping technologies using subtractive, additive and formative processes*, *FME Transactions*, Vol. 48, No. 1, pp. 246-253, 2020.
- [29] Nyman, H. J., Sarlin, P.: *From bits to atoms: 3D printing in the context of supply chain strategies*, in: *47th Hawaii International Conference on System Sciences*, pp. 4190-4199, 2014.
- [30] Liu, H., Ye, S., Zhu, Y., Jin, Y., Yang, W.: *3D face modeling and rapid casting based on reverse design*, in: *IOP Conference Series: Earth and Environmental Science*, IOP Publishing, Vol. 585, No. 1, pp. 012194, 2020.
- [31] Rupal, B. S., Mostafa, K. G., Wang, Y., Qureshi, A. J.: *A reverse cad approach for estimating geometric and mechanical behavior of fdm printed parts*, *Procedia Manufacturing*, Vol. 34, pp. 535-544, 2019.
- [32] Lim, S. K., Hong, E. P., Song, Y. H., Park, B. J., Choi, H. J., Chin, I. J.: *Preparation and interaction characteristics of exfoliated ABS/organoclay nanocomposite*. *Polymer Engineering & Science*, Vol. 50, No. 3, pp. 504-512, 2010.
- [33] Swetham, T., Reddy, K. M. M., Huggi, A., Kumar, M. N.: *A Critical Review on of 3D Printing Materials and Details of Materials used in FDM*, *International Journal of Scientific Research in Science, Engineering and Technology*, Vol. 3, No. 2, pp. 353-361, 2017.

NOMENCLATURE

AT	Additive Technology
RE	Reverse Engineering
FDM	Fused Deposition Modeling
FFF	Fused Filament Fabrication

CAD	Computer Aided Design
STL	Stereo Lithography
ABS	Acrylonitrile Butadiene Styrene
PLA	Polylactic Acid
PETG	Polyethylene Terephthalate Glycol

**ПРИМЕНА АДТИВНЕ ТЕХНОЛОГИЈЕ И
РЕВЕРЗИБИЛНОГ ИНЖЕЊЕРСТВА У
РЕАЛИЗАЦИЈИ ОШТЕЋЕНИХ ЗАСТАРЕЛИХ
ДЕЛОВА**

**М. Воркапић, Д. Живојиновић, Д. Крецуљ,
Т. Иванов, М. Балтић, А. Симоновић**

Реверзбилни инжењеринг (РЕ) има за циљ да пројектује нови заменски део на основу постојећег дела. Поступак се спроводи кроз низ корака: израда

дигиталног 3Д модела, побољшање и оптимизација параметара модела и реализација производа применом адитивних технологија. Циљ је да се изврши квалитетна репродукција физичког дела са најбољим могућим механичким карактеристикама у циљу проналажења оптималних решења у погледу облика и димензија дела. У овом раду је извршен преглед и имплементација основних методологија РЕ на примеру оштећеног заштитног поклопца непознате геометрије и материјала од суштинског значаја за функционисање уређаја који се не производи, а при томе нема расположиве техничке документације и резервних делова. У реализацији репродукованог дела коришћена је метода оптичког скенирања, 3D CAD, FEA и адитивна производња. Показало се да се коришћењем РЕ може значајно продужити животни циклус уређаја уз минималне трошкове.