

R. Dobretsov

Doctor of Engineering
Peter the Great St. Petersburg Polytechnic
University
Russia

I. Troyanovskaya

Doctor of Engineering
South Ural State Agrarian University
South Ural State University
Russia

S. Voinash

Leading engineer
Kazan Federal University
Russia

R. Zagidullin

Candidate of Engineering
Kazan Federal University
Russia

L. Sabitov

Doctor of Engineering
Kazan Federal University
Kazan State Power Engineering University
Russia

A. Nurullin

Senior lecturer
Kazan Federal University
Russia

Kinematic and Force Patterns of Interaction of a Link Caterpillar of a Transport Machine with the Ground

This article proposes a mathematical model of a caterpillar track's force and kinematic interaction with the ground during movement. The presence of a positive displacement of caterpillar tracks was proved even in the absence of slipping. This displacement causes the soil to be sheared and thrown out of the area of contact with the caterpillar. The change in the rotation angles of the tracks and the magnitude of their longitudinal displacement were obtained. A drop in the tension force of the caterpillar track was detected on the active section of the supporting surface between the first and second track wheels. The relationships between the main geometric parameters of the caterpillar track, the vertical load on the track wheels, and the movement of the tracks when the track wheels roll over them are established. Practical recommendations are proposed that contribute to the damping of vibrations when the track roller passes over the caterpillar track.

Keywords: Truck; Parallel Hinge; Caterpillar Tension Force; Positive Track Offset; Slipping; Vertical Oscillation Tracks; Normal Pressure.

1. INTRODUCTION

For caterpillar agricultural tractors, directional stability [1], tractive effort [2], and service life [3] are of great importance. However, the solution to these issues is only possible with an adequate description of the interaction of the caterpillar with the ground.

For a long time, the description of the interaction of a caterpillar with the ground was described by regression models based on the processing of experimental results. This approach only allows for a narrow distribution of models for new types of caterpillars.

Later in the study of the interaction of a caterpillar with the ground, models with a conditionally single whole-bearing surface are most widely used [4-6]. In these models, the normal pressure of the caterpillar on the ground appears to be uniformly distributed (Fig. 1). There are models that take into account parts of the caterpillar [7-8]. However, for the most part, they are based on using the finite element method [9-11].

The designer of a caterpillar seeks to obtain a uniform diagram of normal pressures (Fig. 1a). The presence of a traction force and a longitudinal external force lead to a change in the shape of the diagram to a trapezoid (Fig. 1b). In reality, the normal pressure diagram has peaks under the track wheels and a significant decrease in pressure in the spans between them (Fig. 1c).

However, these models need to take into account the specifics of the operation of the tracks themselves when the track roller passes over them. An increase in longitudinal force often results in an area under the front rollers that is not loaded with normal pressure.

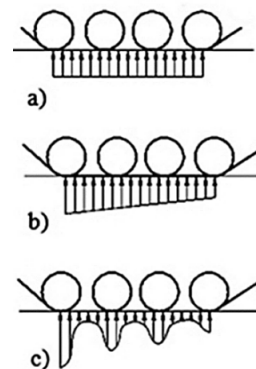

Figure 1. The plot of normal track pressure on the ground: (a) rectangular (ideal); (b) trapezoidal (theoretical); (c) peaked (actual)

This situation is typical for a loaded skidder or tracked vehicle towing a heavy trailer [12]. Most tracked vehicles do not provide design values of normal pressure in the region of 0.005 MPa. Exceeding the design pressure often leads to a loosening of the soil under the caterpillar and its removal from the contact zone, even in the absence of slipping. The theory of the movement of ground vehicles [13] does not explain this effect. Modern models of interaction between a tracked vehicle and the ground [14-15] also do not describe this process.

The effect of soil destruction is environmentally harmful. Reducing the normal load of the caterpillar on the ground will prevent its destruction [16].

Received: April 2023, Accepted: June 2023

Correspondence to: Dr Sergey Voinash, Kazan Federal University, Research Laboratory of Intelligent Mobility, 18 Kremlin Street, Kazan 420008, Russia

E-mail: sergey_voi@mail.ru

doi: 10.5937/fme2303415D

© Faculty of Mechanical Engineering, Belgrade. All rights reserved

FME Transactions (2023) 51, 415-422 415

The purpose of the study is to study the normal pressure of the caterpillar on the ground and to detect its destructive effect. To achieve this goal we:

1. analyze the kinematic and power features of the operation of a caterpillar under various loading conditions;
2. identify the causes of the destructive effect of the caterpillar on the ground at low values of specific thrust;
3. propose measures aimed at reducing the destructive effect of the caterpillar on the ground.

Originality: The description of the interaction of the caterpillar with the ground is based on the concept of the interaction of two adjacent tracks with a non-deformable base. This approach makes it possible to take into account kinematic and force factors and subsequently justify the design changes of the caterpillar.

2. MATERIALS AND METHODS

The average pressure of a caterpillar vehicle on the ground is defined as the ratio of the vehicle's weight to the total area of the tracks. This characteristic can be used in assessing the technical efficiency and environmental safety of the chassis only as a first approximation since it does not take into account the uneven distribution of the load between the track wheels [17-18]. The actual vertical load on individual tracks depends on their specific dimensions and the loads acting on them from the track roller and the ground [19].

2.1 Basic provisions

Caterpillar tracks oscillate in the vertical plane when the track roller rolls along a ringed caterpillar. These vibrations are easily visible to the naked eye. They increase the values of vertical peak loads under the track rollers [20-21].

These peak loads destroy the soil. The localization of loads under a separate track leads to a decrease in the cross-country ability of a tracked vehicle on soft ground such as sand, snow, or swampy soils. It is accompanied by intense rutting [22-23]. During vertical vibrations, the tracks capture and compact soft ground. Solid ground cushions are formed on the supporting surface of the track, which are not dropped even when the track is rewound (Fig. 2).



Figure 2. Clogging of caterpillar tracks with snow and formation of soil (snow) cushions

During oscillation, the caterpillar tracks move slightly forward. The offset amount depends on the track chain's design features. This phenomenon is called the positive displacement (skidding) of the tracks under

load. This phenomenon is observed even in the absence of slippage and is accompanied by the destruction of the soil [24]. Such destruction damages the base with a weak surface layer [25-28].

The loss of the tension force of the supporting surface of the caterpillar track accompanies the positive displacement of the tracks. As a result, sections of the track that are not loaded with tensile force appear between the first and second track rollers. Reducing track tension increases the likelihood of track drop. At the same time, the front rollers seem to sink into the ground, which leads to a decrease in the vehicle's cross-country ability and increases the destruction of the soil base.

Two-link tracked vehicles are used to minimize the average pressure on the ground. However, insufficient track preload on a passive trailer creates a similar effect. The resulting instability of the tracks reduces the efficiency of using passively tracked trailers due to an increase in energy losses during their towing [29-30].

Researchers on vehicles of different weights and caterpillar designs have observed the tracks' instability and the associated consequences. However, the positive displacement of tracks under load for modern high-speed tracked vehicles remains practically unexplored.

2.2 Choice of vibration suppression method

There are several ways to suppress the vibrations of tracks on the supporting surface of the caterpillar track and reduce the negative consequences of this phenomenon on the ground [31].

1. The introduction of elastic elements (for example, rubber shoes) into the design of the treadmill, the deformation of which prevents the vertical vibrations of the tracks. The disadvantage of this method is increased losses in the propulsion unit due to the deformation of rubber parts [32].

2. A staggered arrangement of track wheels: This method was used on German "Tiger" and "Panther" tanks and is most effective for large-sized caterpillar tracks (Fig. 3). The disadvantage of this method is the significant complication and weight of the entire system [33].



Figure 3. Caterpillar undercarriage system with staggered track wheels

3. Increasing the contact area of the track roller with the track by reducing the track pitch and using track rollers with external shock absorption. In this case, the track roller rolls over two or three adjacent tracks at once, which minimizes track oscillations. Currently, in

undercarriage systems of modern high-speed tracked vehicles, there is a tendency to spread small-linked tracks [34]. This direction can be considered promising.

4. The optimization of the arrangement of lugs [35]. Moving the lugs from under the hinge axis to the edge of the link reduces the time when the track roller rolls over the hinge axis and reduces the vertical vibrations of the track. Such modernization, affecting only track design, is characterized by minimal costs for the improvement of the caterpillar and does not affect the weight of the undercarriage system [36].

Moving the lug behind the hinge axis minimizes the turning force arm A (Fig. 4), which helps to reduce losses in propulsion. Improving the movement helps to reduce losses in the propulsion unit while maintaining the high cross-country ability of the vehicle. This method is most effective when driving on hard ground [37].

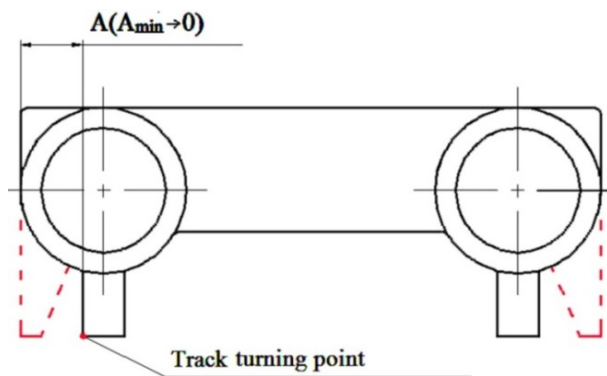

Figure 4. Modification of the supporting surface of the track by transferring the grouser

The positive displacement of the tracks depends on the geometric dimensions of the undercarriage and the forces acting on its elements. To select dimensions when designing a caterpillar with reduced environmental hazard, it is necessary to study in more detail the mechanics of the interaction of the track with the track roller and the ground. For this, a mathematical model of the interaction force of the track was developed. The model is based on the idea of a track link chain having the corresponding mass and specific elastic charac-

teristics of the hinges. The substantiation of the geometric and kinematic characteristics of the caterpillar will minimize power losses and the destructive impact on the ground [38].

2.3 Mathematical model

When constructing the model, the following initial positions were taken [39]:

- the vehicle is moving on a horizontal surface;
- a non-deformable base was chosen as the ground since interaction with it contributes to the greatest positive displacement of the tracks [40];
- rollers have external shock absorption, which is characterized by increased power losses in the propulsion;
- the connection of track chain links has a rubber-metal hinge of parallel type, for which the positive displacement of the tracks is most typical;
- the load from the track roller on adjacent tracks is distributed [41].

Let us consider the interaction of a single-track roller with a radius R_0 with two adjacent tracks of a caterpillar track chain with a step t , connected by a parallel rubber-metal hinge, which determines the size of the gap between the tracks, ε (Fig. 5).

In the presence of the external cushioning of the roller, a contact surface appears between the tire and the treadmill of the track. We connect the local coordinate system x_0y with the axis of the track roller. The distributed load $q(x)$ from the side of the track roller to adjacent tracks has a parabolic law [42]

$$q(x) = \frac{0.75P(a^2 - x^2)}{a^3} \quad (1)$$

where $P = P_i + P_{i+1}$ is the normal force from the side of the track roller; a is half the length of the contact surface of the track roller with the track treadmill; P_i and P_{i+1} are the components of force P , acting on adjacent tracks:

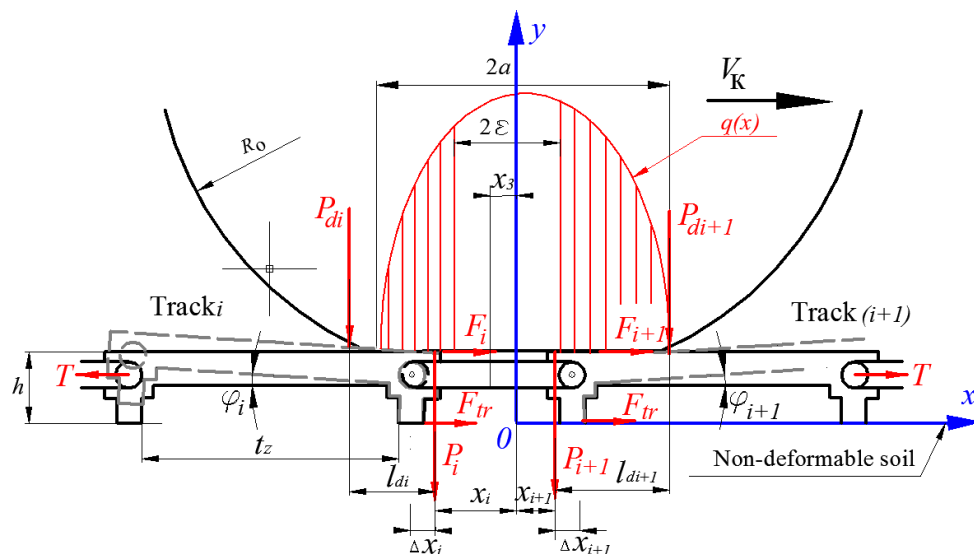

Figure 5. Model of force interaction during rolling of a deformable track roller on adjacent tracks

$$P_i = \int_{-a}^{x_3} q(x) dx \equiv \beta_i(x_3) \frac{P}{2} \quad (2)$$

$$P_{i+1} = \int_{x_3}^a q(x) dx \equiv \beta_{i+1}(x_3) \frac{P}{2}$$

where x_3 is the longitudinal coordinate of the middle of the gap between adjacent tracks relative to the axis of the track roller (located in the range $-a + \varepsilon < x_3 < a - \varepsilon$) (Fig. 5).

The coordinates x_i and x_{i+1} of the points of application of the vertical forces P_i and P_{i+1} in the local coordinate system x_0y are constantly changing and are determined through the integrals:

$$x_i = \frac{\int_{-a}^{x_3-\varepsilon} xq(x) dx}{\int_{-a}^{x_3-\varepsilon} q(x) dx} \equiv \gamma_i(x_3, \varepsilon) \quad (3)$$

$$x_{i+1} = \frac{\int_{x_3+\varepsilon}^a xq(x) dx}{\int_{x_3+\varepsilon}^a q(x) dx} \equiv \gamma_{i+1}(x_3, \varepsilon)$$

where ε is half the gap between adjacent tracks.

After integration, we have

$$\beta_i(x_3) = 1 - 0.5 \left(\frac{x_3}{a} \right)^3 + 1.5 \left(\frac{x_3}{a} \right) \quad (4)$$

$$\beta_{i+1}(x_3) = 1 + 0.5 \left(\frac{x_3}{a} \right)^3 - 1.5 \left(\frac{x_3}{a} \right)$$

For any value x_3 , $\beta_i(x_3) + \beta_{i+1}(x_3) = 2$.

Therefore, the total normal force from the side of the track roller is:

$$P = P_i + P_{i+1} = 0.5P [\beta_i(x_3) + \beta_{i+1}(x_3)] \quad (5)$$

After transformations, we get

$$\gamma_i(x_3, \varepsilon) = \frac{-3 \left(\left[\frac{(x_3 - \varepsilon)}{a} \right]^2 - 1 \right)}{8 \left(-0.5 \left[\frac{(x_3 - \varepsilon)}{a} \right]^3 + 1.5 \left[\frac{(x_3 - \varepsilon)}{a} \right] + 1 \right)} \quad (6)$$

$$\gamma_{i+1}(x_3, \varepsilon) = \frac{3 \left(\left[\frac{(x_3 - \varepsilon)}{a} \right]^2 - 1 \right)}{8 \left(0.5 \left[\frac{(x_3 - \varepsilon)}{a} \right]^3 + 1.5 \left[\frac{(x_3 - \varepsilon)}{a} \right] + 1 \right)}$$

According to the theory of the rolling of a deformable wheel on a solid base [43], the normal pressures P_i and P_{i+1} are shifted forward relative to the roller axis by Δx . Then the turning moments about the axis of the track roller have the form:

$$M_i = 0.5P [a\gamma_i(x_3, \varepsilon) + \Delta x] \beta_i(x_3) \quad (7)$$

$$M_{i+1} = 0.5P [a\gamma_{i+1}(x_3, \varepsilon) - \Delta x] \beta_{i+1}(x_3)$$

The total moment about the axis of the track roller is:

$$M = M_i + M_{i+1} = P [\Delta x + 0.5a\zeta(x_3, \varepsilon)] \quad (8)$$

where $\zeta(x_3, \varepsilon) = \beta_i(x_3)\gamma_i(x_3, \varepsilon) + \beta_{i+1}(x_3)\gamma_{i+1}(x_3, \varepsilon)$.

In addition to vertical forces, horizontal forces F_i and F_{i+1} also act on adjacent tracks from the side of the track roller. Their values are calculated by dividing the turning moment's M_i and M_{i+1} (7) by the radius of the track roller R_0 :

$$F_i = \frac{M_i}{R_0} = 0.5P \beta_i(x_3) \frac{\alpha\gamma_i(x_3, \varepsilon) + \Delta x}{R_0} \quad (9)$$

$$F_{i+1} = \frac{M_{i+1}}{R_0} = 0.5P \beta_{i+1}(x_3) \frac{\alpha\gamma_{i+1}(x_3, \varepsilon) - \Delta x}{R_0}$$

The rotation of adjacent tracks at angles φ_i and φ_{i+1} leads to additional displacement of vertical forces P_i and P_{i+1} in different directions from the roller axis by $\Delta x_i = \varphi_i R_0$ and $\Delta x_{i+1} = \varphi_{i+1} R_0$. Then the horizontal forces take the form:

$$F_i = 0.5P \beta_i(x_3) \left[\varphi_i + \frac{\alpha\gamma_i(x_3, \varepsilon) + \Delta x}{R_0} \right] \quad (10)$$

$$F_{i+1} = 0.5P \beta_{i+1}(x_3) \left[\varphi_{i+1} + \frac{\alpha\gamma_{i+1}(x_3, \varepsilon) - \Delta x}{R_0} \right]$$

The sum of the horizontal forces is:

$$F_i + F_{i+1} = P \left\{ \frac{\Delta x + 0.5a\zeta(x_3, \varepsilon)}{R_0} + 0.5[\varphi_i \beta_i(x_3) + \varphi_{i+1} \beta_{i+1}(x_3)] \right\} \quad (11)$$

Since $\varphi_i < 0$ and $\gamma_i < 0$, and the force F_i decreases, we get $\varphi_{i+1} > 0$. When $\gamma_{i+1} > 0$, the force F_{i+1} will increase. After converting the equations of moments, expressions were obtained to determine the angles of rotation of the tracks φ_i and φ_{i+1} under the track roller:

$$\varphi_i \left[\frac{(T + F_{tr})t_z}{P_i} + R_0 - h \right] + \left[\frac{M_{ai}}{P_i} - x_i + \frac{h(x_i + \Delta x)}{R_0} \right] - \frac{P_{di}}{P_i} l_{di} \sqrt{\varphi_i^3} = 0 \quad (12)$$

$$\varphi_{i+1} \left[\frac{(T + F_{tr})t_z}{P_{i+1}} + R_0 - h \right] + \left[\frac{M_{ai+1}}{P_{i+1}} - x_{i+1} + \frac{h(x_{i+1} + \Delta x)}{R_0} \right] - \frac{P_{di+1}}{P_{i+1}} l_{di+1} \sqrt{\varphi_{i+1}^3} = 0 \quad (13)$$

where T is track pull force; F_{tr} is sliding friction force between track and ground; t_z is the pitch of the track; R_0 is the track roller radius; h is the track height, taking into account soil cushions between the lugs; M_{ai} , M_{ai+1} are the moment of inertia of the tracks; x_i , x_{i+1} are the shoulders of vertical forces P_i and P_{i+1} ; P_{di} , P_{di+1} are the elastic forces during the deformation of the external shock absorption of the track roller when turning the track; $l_{di} = a(1 + \gamma_i)$, $l_{di+1} = a(1 + \gamma_{i+1})$ are the shoulders of elastic forces P_{di} and P_{di+1} .

The positive offset of adjacent tracks l_i and l_{i+1} was determined by:

$$l_i = \varphi_i \Delta h, l_{i+1} = \varphi_{i+1} \Delta h \quad (14)$$

where Δh is the distance from the middle of the gap between adjacent tracks to the edge of the lug.

The displacement value of a single track l_i and l_{i+1} depends on the geometric characteristics of the chassis (the radius of the track roller R_0 , the position of the lugs, the track pitch t_z , and the track height h), the vertical load on the roller P_{i+1} , the damping stiffness of the track roller P_{di+1} , the rolling speed of the track roller, and the tension force of the caterpillar track T .

3. RESULTS

The result of a numerical experiment based on the mathematical model (equations 1-14) is the calculation of the positive displacement of the tracks. The calculations were carried out on the example of the running system of a high-speed tracked infantry fighting vehicle BMP-1 (Fig. 6).

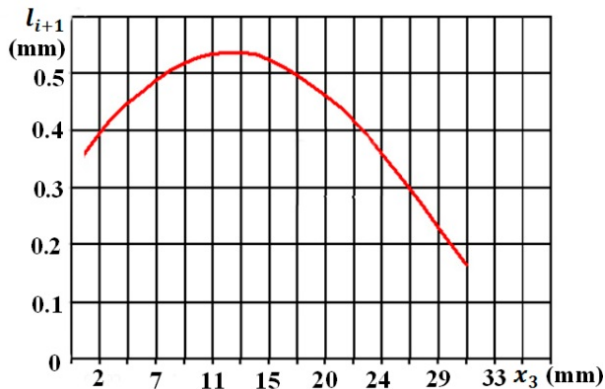

Figure 6. The dependence of the displacement of the track l_{i+1} on the longitudinal distance of the center of the gap to the axis of the track wheels x_3

The total displacement is the sum of the displacements of a pair of adjacent tracks during the rolling of the next track roller. There is a cumulative effect that is proportional to the number of rollers (Fig. 7).

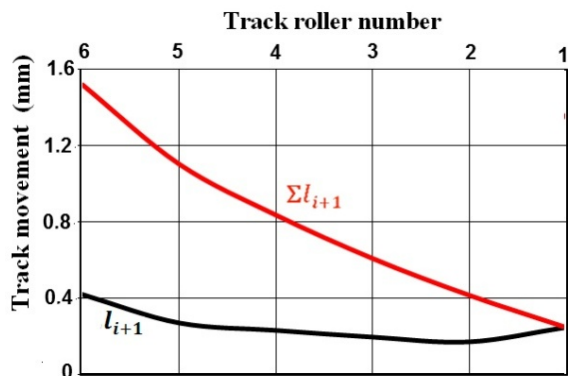

Figure 7. The displacement of a single track l_{i+1} and the total displacement of all tracks in contact with the ground Σl_{i+1} from the number of track wheels passed through them

The value of the track tension T between two track wheels can be very different. The drop in the tension force of the caterpillar track T is directly related to the positive displacement of the tracks l_{i+1} . An increase in the tension force T of the caterpillar track leads to a decrease in the angle of rotation of the track φ . This result is also confirmed by other authors [44].

When constructing the graph of the tensile forces in the supporting surface, only active sections which transmit vertical loads when the rollers roll along the

tracks were taken into account. On the supporting surface of the caterpillar-tracked BMP-1 between the front rollers, areas not loaded with tensile force were found (Fig. 8).

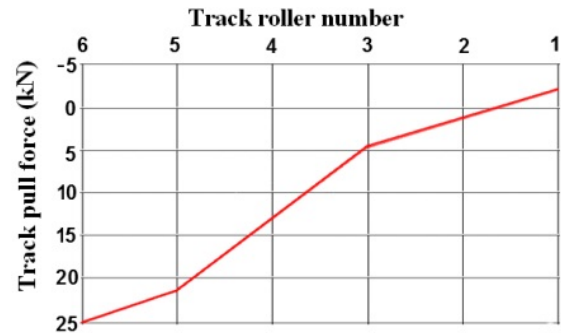

Figure 8. Distribution of tensile forces of the supporting branch of the BMP-1 caterpillar

Losses of track tension ΔT during the passage of the track roller are associated with the instability of the tracks and are made up of elementary losses under the track rollers (Fig. 9).

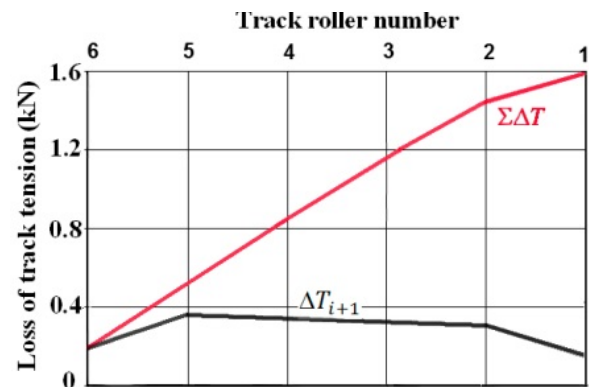

Figure 9. The drop in the tension force of the caterpillar under the track wheels as a result of the positive displacement of a single track Δt_{i+1} and all tracks of the support branch $\Sigma \Delta T$.

4. CONCLUSIONS

A vehicle with a caterpillar, when moving, destroys the soil with its track causing environmental damage. The reason for this is the vertical vibrations of the tracks when the track wheels pass over them. A mathematical model of the power and kinematic interaction of adjacent tracks with a track roller during movement has been developed. The calculations were carried out using a six-roller undercarriage system of the BMP-1 high-speed tracked vehicle with a parallel rubber-metal hinge, theoretically confirming the positive displacement of the tracks even in the absence of slipping. This displacement of the tracks causes the soil to be sheared and thrown out of the contact area.

Based on the mathematical model, a numerical experiment was carried out. The change in the rotation angles of the tracks and the magnitude of the displacement of adjacent links were obtained. Qualitative and quantitative relationships have been established between the main geometric parameters of the caterpillar, the vertical load on the track wheels, and the displacement of the tracks when the road wheel rolls over them. A drop in the tension force of the track was detected on

the active section of the supporting surface between the first and second track wheels.

The analysis of methods for suppressing vertical vibrations of tracks was carried out. Practical recommendations are proposed for changing the design of the track, which caterpillar to the suppression of vibrations of the tracks during the passage of the track roller over them. The transfer of the lugs to the edge of the track, together with the overlapping of the gap between adjacent tracks, makes it possible to reduce the instability of the tracks when the track rollers roll over them. Such changes affect only the design of the tracks and reduce the peaks of the normal reaction under the track wheels.

The research results have found practical applications in the design of link caterpillars for transport and traction-transport and road-building machines. A change in the placement of lugs has been noticed on the tracks of Russian tank support combat vehicles. The designs of modern German military tracked vehicles of various weight categories are characterized by a "staggered" arrangement of track rollers and partial overlapping of the gaps between the tracks. The caterpillar design has been patented (Semenov et al., 2011), the hinges and lugs of which are placed in accordance with the recommendations given in this article.

ACKNOWLEDGMENTS

The work was carried out within the framework of the Strategic Academic Leadership Program of the Kazan (Volga Region) Federal University ("PRIORITET-2030").

REFERENCES

- [1] Troyanovskaya, I., Zhakov, A., Grebenshchikova, O., Voinash, S. and Timofeev, E. Directional Stability of an Agricultural Tractor. *FME Transactions*, vol. 49, no. 2, pp. 456-462, 2021. doi:10.5937/fme2102456T
- [2] Shepelev, S., Pyataev, M. and Kravchenko, E. Study of the Tractive Resistance of the No-till Planting Section. *FME Transactions*, vol. 50, no. 3, pp. 502-511, 2022. doi:10.5937/fme2203502S
- [3] Rusiński, E., Czmochowski, J., Moczko, P. and Pietrusiak, D. Challenges and Strategies of Long-life Operation and Maintenance of Technical Objects. *FME Transactions*, vol. 44, no. 3, pp. 219-228, 2016. doi:10.5937/fmet1603219R
- [4] Wong, J.Y., Garber, M. and Preston-Thomas, J. Theoretical Prediction and Experimental Substantiation of the Ground Pressure Distribution and Tractive Performance of Tracked Vehicles, *Proceedings of the Institution of Mechanical Engineers, Part D: Transport Engineering*, vol. 198, no. 4, pp. 265-285, 1984. doi:10.1243/PIME_PROC_1984_198_155
- [5] Smith, D.L.O. and Dickson, J.W. Contributions of vehicle weight and ground pressure to soil compaction, *Journal of Agricultural Engineering Research*, vol. 46, pp. 13-29, 1990. doi:10.1016/S0021-8634(05)80110-6
- [6] Khitrov, E.G. and Andronov, A.V. Comparison of the forest machine mover average and nominal pressure on the soil, *IOP Conference Series: Materials Science and Engineering*, vol. 695, article no. 012021, 2019. doi:10.1088/1757-899X/695/1/012021
- [7] Dobretsov, R.Y., Sokolova, V.A., Teterina, I.A., Malyukov, S.V., Aksenov, A.A. and Smertin, N.V. Interaction feature of caterpillar tracks with soil under significant axial displacements of pressure center, *IOP Conference Series: Earth and Environmental Science*, vol. 839, no. 5, article no. 052023, 2021. doi:10.1088/1755-1315/839/5/052023
- [8] Pei, T., Yan, B., Liu, Z. and Zhao, Z. Dynamic ground pressure prediction of heavy-duty construction vehicles considering crawler parameters, *Journal of the Brazilian Society of Mechanical Sciences and Engineering*, vol. 45, no. 3, pp. 1-13, 2023. doi:10.1007/s40430-023-04076-2
- [9] Abyzov, A.A. and Berezin, I.I. FEM Simulation of Tracks with Soil Interaction in Curvilinear Motion of Tracked Vehicle, *Lecture Notes in Mechanical Engineering*, pp. 736-743, 2021. doi:10.1007/978-3-030-54814-8_85
- [10] Hetherington, J.G. The applicability of the MMP concept in specifying off-road mobility for wheeled and tracked vehicles, *Journal of Terramechanics*, vol. 38, no. 2, pp. 63-70, 2001. doi:10.1016/S0022-4898(00)00010-0
- [11] Zhang, R. and Li, J. Simulation on mechanical behavior of cohesive soil by Distinct Element Method, *Journal of Terramechanics*, vol. 43, no. 3, pp. 303-316, 2006. doi:10.1016/j.jterra.2005.05.006
- [12] Grečenko, A. Re-examined principles of thrust generation by a track on soft ground, *Journal of Terramechanics*, vol. 44, no. 1, pp. 123-131, 2007. doi:10.1016/j.jterra.2006.04.002
- [13] Wong, J.Y. Theory of ground vehicles, 5th Edition, *John Wiley & Sons*, 2022.
- [14] Derzhanskiy, V.B., Taratorkin, I.A., Volkov, A.A. and Yakovlev, A.G. Regularities of interaction between a caterpillar drive and a supporting base, *AIP Conference Proceedings*, vol. 2503, no. 1, article no. 080017, 2022. doi:10.1063/5.0099390
- [15] Normirzayev, A.R., Nuriddinov, A.D. and Tukhtabayev, M.A. Undercarriages impact on soil of machine-tractor units during tillage and cultivation of agricultural crops. *AIP Conference Proceedings*, vol. 2612, no. 1, article no. 030032, 2023. doi:10.1063/5.0113658
- [16] Stroganov, Y.N., Aldokhina, N.P., Vikhrova, T.V., Glazova, L.P., Dolgushin, V.A., Krishtanov, E.A., Ognev, O.G. and Summanen, A.V. Reduction of technogenic impact on the soil by increasing the stability of road trains movement within the field, *IOP Conference Series: Earth and Environmental Science*, vol. 1138, no. 1, article no. 012031, 2023. doi:10.1088/1755-1315/1138/1/012031

- [17] Garber, M. and Wong, J.Y. Prediction of ground pressure distribution under tracked vehicles-II. Effects of design parameters of the track-suspension system on ground pressure distribution, *Journal of Terramechanics*, vol. 18, no. 2, pp. 71–79, 1981. doi:10.1016/0022-4898(81)90001-X
- [18] Dhir, A. and Sankar, S. Analytical Track Models for Ride Dynamic Simulation of Tracked Vehicles, *Journal of Terramechanics*, vol. 31, no. 2, pp. 107–138, 1994. doi:10.1016/0022-4898(94)90010-8
- [19] Garber, M. and Wong, J.Y. Prediction of ground pressure distribution under tracked vehicles-I. An analytical method for predicting ground pressure distribution, *Journal of Terramechanics*, vol. 18, no. 1, pp. 1-23, 1981. doi:10.1016/0022-4898(81)90015-X
- [20] Hartleb, J. and Ketting, M. Stable algorithm to simulate dynamic undercarriage loads of tracked vehicles, *Archives of Civil and Mechanical Engineering*, vol. 11, no. 4, pp. 867-874, 2011. doi:10.1016/S1644-9665(12)60083-1
- [21] Troyanovskaya, I., Grebenshchikova, O. and Zhitenko, I. Process of Soil Destruction: Experimental Results, *MATEC Web of Conferences*, vol. 298, article no. 00041, 2019. doi:10.1051/mateconf/201929800041
- [22] Liu, W. and Cheng, K. An Analytical Model for Predicting Ground Pressure under a Rigid-Flexible Tracked Vehicle on Soft Ground, *Mathematical Problems in Engineering*, vol. 2020, 2020. doi:10.1155/2020/6734121
- [23] Halvorson, J.J., McCool, D.K., King, L.G. and Gatto, L.W. Soil compaction and over-winter changes to tracked-vehicle ruts, Yakima Training Center, Washington, *Journal of Terramechanics*, vol. 38, no. 3, pp. 133-151, 2001. doi:10.1016/S0022-4898(00)00017-3
- [24] Arvidsson, J., Trautner, A., van den Akker, J.J.H. and Schjonning, P. Subsoil compaction caused by heavy sugarbeet harvesters in southern Sweden II. Soil displacement during wheeling and model computations of compaction, *Soil and Tillage Research*, vol. 60, no. 1-2, pp. 79-89, 2001. doi:10.1016/S0167-1987(01)00168-4
- [25] Braunack, M.V. The residual effects of tracked vehicles on soil surface properties, *Journal of Terramechanics*, vol. 21, no. 1, pp. 37-50, 1986. doi:10.1016/0022-4898(86)90030-3
- [26] Hadas, A. Soil compaction caused by high axle loads – review of concepts and experimental data, *Soil and Tillage Research*, vol. 29, no. 2–3, pp. 253-276, 1994. doi:10.1016/0167-1987(94)90064-7
- [27] Jansson, K.J. and Johansson, J. Soil changes after traffic with a tracked and a wheeled forest machine: a case study on a silt loam in Sweden, *Forestry*, vol. 71, no. 1, pp. 57-66, 1998. doi:10.1093/forestry/71.1.57
- [28] Cambi, M., Certini, G., Neri, F. and Marchi, E. The impact of heavy traffic on forest soils: A review, *Forest Ecology and Management*, vol. 338, pp. 124–138, 2015. doi:10.1016/j.foreco.2014.11.022
- [29] Bygdén, G., Eliasson, L. and Wästerlund, I. Rut depth, soil compaction and rolling resistance when using bogie tracks, *Journal of Terramechanics*, vol. 40, no. 5, pp. 179-90, 2003. doi:10.1016/j.jterra.2003.12.001
- [30] Dobretsov, R.Yu., Dobretsova, S.B., Sokolova, V.A., Orlovskiy, S.N., Donin, A.Ya., Garbuzova, T.G. and Alekseeva, S.V. To the problem of reducing the impact on soil during mechanization of thinning, *IOP Conference Series: Earth and Environmental Science*, vol. 981, no. 4, article no. 042089, 2022. doi:10.1088/1755-1315/981/4/042089
- [31] Spanos, P.D. Traditional and Emerging Techniques for Practical Random Vibration Analyses. *FME Transactions*, vol. 42, no. 4, pp. 265-268, 2016. doi:10.5937/fmet1404265S
- [32] Ansorge, D. and Godwin, R.J. The effect of tyres and a rubber track at high axle loads on soil compaction. Part 1: Single axle-studies, *Biosystems Engineering*, vol. 98, no. 1, pp. 115-126, 2007. doi:10.1016/j.biosystemseng.2007.06.005
- [33] Salavrakos, I.D. A re-assessment of the German armaments production during World War II, *Scientia Militaria: South African Journal of Military Studies*, vol. 44, no. 2, pp. 113-145, 2016. doi:10.5787/44-2-1178
- [34] Edlund, J., Keramati, E. and Servin, M. A long-tracked bogie design for forestry machines on soft and rough terrain, *Journal of Terramechanics*, vol. 50, no. 2, pp. 73–83, 2013. doi:10.1016/j.jterra.2013.02.001
- [35] Milenković, B., Jovanović, Đ. and Krstić, M. An Application of Dingo Optimization Algorithm (DOA) for Solving Caterpillar Engineering Problems. *FME Transactions*, vol. 50, no. 2, pp. 331-338, 2022. doi:10.5937/fme2201331M
- [36] Dobretsov, R.Yu., Voinash, S.A., Ariko, S.Ye. and Sidorov, M.V. Comprehensive Modernization of the Chassis of a Two-Link Tracked Transporter, *IOP Conference Series: Materials Science and Engineering*, vol. 1079, article no. 072002, 2021. doi:10.1088/1757-899X/1079/7/072002
- [37] Yang, C., Cai, L., Liu, Z., Tian, Y. and Zhang, C. A calculation method of track shoe thrust on soft ground for splayed grouser, *Journal of Terramechanics*, vol. 65, no. 1, pp. 38–48, 2016. doi:10.1016/j.jterra.2016.02.001
- [38] Vesović, M.V., Petrović, G.R. and Radulović, R.D. Analysis of the Motion and Stability of the Holonomic Mechanical System in the Arbitrary Force Field. *FME Transactions*, vol. 49, no. 1, pp. 195-205, 2021. doi:10.5937/fme2101195V
- [39] Özdemir, M.N., Khlh, V. and Ünlüsoy, Y.S. A New Contact and Slip Model for Tracked Vehicle Transient Dynamics on Hard Ground, *Journal of Terramechanics*, vol. 73, pp. 3–23, 2017. doi:10.1016/j.jterra.2017.07.001

- [40] Wong, J.Y. and Chiang, C.F. A general theory for skid steering of tracked vehicles on firm ground. Proceedings of the Institution of Mechanical Engineers, Part D: *Journal of Automobile Engineering*, vol. 215, no. 3, pp. 343-355, 2001. doi:10.1243/0954407011525683
- [41] Blunden, B.G., McBride, R.A., Daniel, H. and Blackwell, P.S. Compaction of an earthy sand by rubber tracked and tired vehicles, *Australian Journal of Soil Research*, vol. 32, no. 6, pp. 1095-1108, 1994. doi:10.1071/SR9941095
- [42] Kokieva, G.E., Troyanovskaya, I.P., Orekhovskaya, A.A., Kalimullin, M.N., Dzasheev, A.-M.S., Ivanov, A.A. and Sokolova, VA Research of Soil Compaction Process in Area of Contact with a Wheel Mover, *Journal of Physics: Conference Series*, vol. 2094, article no. 042003, 2021. doi:10.1088/1742-6596/2094/4/042003
- [43] Troyanovskaya, I.P. and Pozin, B.M. Forces of Friction at the Wheel-to-Ground Contact in a Turning Vehicle, *Procedia Engineering*, vol. 129, pp. 156-160, 2015. doi:10.1016/j.proeng.2015.12.025
- [44] Wong, J.Y. and Huang, W. An Investigation into the Effects of Initial Track Tension on Soft Ground Mobility of Tracked Vehicles Using an Advanced Computer Simulation Model. Proceedings of the Institution of Mechanical Engineers, Part D: *Journal of Automobile Engineering*, vol. 220, no. 6, pp. 695-711, 2006. doi:10.1243/09544070JAUTO5
- [45] Semenov A.G, Dobretsov R.Yu., Lozin A.V., Uvakina D.V. 2011. Caterpillar with rubber-metal joint of parallel type and lantern gearing with drive wheel. Patent RU 2761974

NOMENCLATURE

P_i, P_{i+1}	components of the vertical force acting on adjacent tracks
P	the total vertical force acting from the track roller
x_i, x_{i+1}	longitudinal coordinates of the points of application of vertical forces P_i and P_{i+1} relative to the axis of the track roller
x_3	longitudinal coordinate of the middle of the gap between adjacent tracks relative to the axis of the track roller
ε	half gap between adjacent tracks
A	half the length of the contact patch of the track roller with the track treadmill

Δx	displacement of vertical reactions P_i, P_{i+1} forward by changing the diagram of normal pressures during the movement of the track roller
$\Delta x_i, \Delta x_{i+1}$	displacement of vertical reactions P_i, P_{i+1} in different directions due to the rotation of the tracks
φ_i, φ_{i+1}	angles of rotation of adjacent tracks when the track roller moves along the tracks
R_0	track roller radius
M_i, M_{i+1}	turning moments acting on adjacent tracks
T	track pull force
F_{tr}	the sliding friction force between track and ground
t_z	caterpillar pitch
h	the track height, taking into account soil cushions between the lugs
M_{ai}, M_{ai+1}	moment of inertia of tracks
P_{di}, P_{di+1}	elastic force during the deformation of the external shock absorption of the track roller when turning the track
l_{di}, l_{di+1}	shoulders of elastic forces P_{di} and P_{di+1}

КИНЕМАТИЧКИ И СИЛАЗНИ ОБРАСЦИ ИНТЕРАКЦИЈЕ ЛАНЧАНЕ ГУСЕНИЦЕ ТРАНСПОРТНЕ МАШИНЕ СА ТЛОМ

**Р. Добреци, И. Тројановскаја, С. Војнаш,
Р. Загидуљин, Ј. Сабитов, А. Нуруљин**

Овај чланак предлаже математички модел силе гусенице и кинематичке интеракције са тлом током кретања. Доказано је присуство позитивног померања гусеница иу одсуству клизања. Ово померање доводи до тога да се земљиште скрати и избаци из подручја контакта са гусеницом. Добијена је промена угла ротације колосека и величина њиховог уздужног померања.

На активном делу потпорне површине између првог и другог колосека детек-тован је пад силе затезања гусенице. Установљавају се односи између главних геометријских параметара гусеничарског колосека, вертикалног оптерећења на точковима гусенице и кретања гусеница када се гусечни точкови преврћу преко њих. Предложене су практичне препоруке које доприносе пригушењу вибрација када гусеничарски ваљак прелази преко гусеничарске стазе.