

Predicting Automotive Air Conditioning System Performance through Deep Learning

Pradipkumar M. Gavali

Research Scholar
Rajarambapu Institute of Technology
Rajaramnagar, Sangli
Shivaji University, Kolhapur
Faculty of Mechanical Engineering
Maharashtra
India

S. D. Yadav

Professor
Rajarambapu Institute of Technology
Rajaramnagar, Sangli
Faculty of Automotive Technology
India

Automotive Air Conditioning System (AACS) involves phase change of the refrigerant, to provide a comfortable environment in the vehicle cabin. The phase change is governed by many complex equations. Therefore, a technique that can validate the results and predict the system performance is required to avoid tedious calculations. Deep Neural Networks (DNN) are better at learning complex non-linear relationships between performance metrics. Experimental data is used to train the specified DNN model. Compressor speed, air temperature at the inlet of the evaporator, and refrigerant flow rate are used as input, while coefficient of performance, compressor work, and heat loss have been used as output parameters to train the model. Predicted results are compared by using statistical measures such as Root Mean Square Error, Mean Square Error as well as Correlation Coefficient. Based on the results obtained, the specified DNN model can be effectively used in predicting and validating the performance of the AACS.

Keywords: Deep Neural Network, Automotive Air Conditioning System, prediction of performance, coefficient of performance, heat loss

1. INTRODUCTION

An Automotive Air Conditioning System (AACS) is used for conditioning the air so that the environment inside the passenger compartment becomes comfortable. AACS maintains proper conditions within the car with the help of four primary components (compressor, condenser, expansion valve, and evaporator). The compressor of the AACS is attached to the engine using a belt drive. Therefore the speed of the compressor is administered by the engine. The engine's operating conditions change throughout the journey since they can range from idling in rush-hour traffic to running at high speeds on the interstate. Assortment in the climate conditions, as well as driving conditions, leads to complications in AACS compared to the static air conditioning system as given by Kargilis [1]. Air conditioning systems also affect the temperature and speed of the engine as described by Bamisaye et al. [2]

The performance of the AACS was studied experimentally by numerous researchers before its development in computer technology. The experimental procedures are more costly because of the initial expenditure required to construct an experimental setup, whereas the theoretical study entails more assumptions and complex equations. To overcome these limitations soft computing techniques have gained more importance in the recent past. Development in techniques like Artificial Neural Networks (ANN), genetic programming, fuzzy logic control, and data mining contributes to a wide range of applications. Thermal engineering is one of the

key applications in it. The fundamental reason why ANN is gaining popularity is that it is effective at identifying the intrinsic relation between any set of inputs and outputs that do not require a physical model, regardless of how complicated the relationships are, how many variables are present, how uncertain the input and output data are, and how external, unknowable parameters may affect performance.

ANNs are computational models inspired by the structure and function of biological neural networks. They consist of interconnected nodes organized into layers including input, hidden, and output layers. Each connection between nodes is associated with a weight that is adjusted during the learning process. DNNs, on the other hand, are a specific type of ANN that contains multiple hidden layers between the input and output layers. These deep architectures allow for more complex representations of data to be learned compared to shallow neural networks with fewer hidden layers. In summary, DNNs are a specialized form of ANN with multiple hidden layers, enabling them to learn intricate representations of data for various tasks. While ANNs provide the foundation, DNNs extend this architecture to handle more complex learning tasks by leveraging deep hierarchical representations.

AACS performance is governed by complex equations. Moreover, the operating conditions of the system such as engine speed, inlet air temperature, and mass flow rate of the refrigerant are dynamically changing. During operation, refrigerant undergoes phase change. The phase change of the refrigerant through micro channels is not yet completely understood. Hence general set of equations can't be applied to the system which will give accurate results irrespective of operating conditions. Traditional methods may struggle to handle high-dimensional data effectively. Calculation of these complex sets of

Received: January 2024, Accepted: June 2024

Correspondence to: Pradipkumar M. Gavali
Faculty of Mechanical Engineering,
RIT, Shivaji University, Maharashtra, India.
E-mail: gavalipm89@gmail.com

doi: 10.5937/fme2403440G

© Faculty of Mechanical Engineering, Belgrade. All rights reserved

FME Transactions (2024) 52, 440-449 440

equations is time-consuming and costlier. To overcome these problems, the DNN model is developed to predict the performance of AACs at different operating conditions. The performance of AACs is measured in terms of coefficient of performance, heat loss, and compressor work. Therefore these parameters are considered as output of the DNN predictions in this research work. In summary, the DNN model is developed to obtain more accurate results and predict the results in any operating conditions without traditional tedious calculations.

2. LITERATURE REVIEW

The use of ANN in different fields is growing to avoid the complexity of the problems to be solved, but on the counter, it should not hamper the accuracy of the results obtained. Deep learning has a wide range of applications for example – autonomous vehicles, facial recognition, object detection, image segmentation, sentiment analysis, Machine translation, Disease diagnosis, Risk assessment, financial forecasting, energy forecasting, etc. In this research deep learning is used to predict the outcomes of the AACs without tedious calculations. The use of ANN and DNN is summarized below-

According to Yang [3], two more benefits of using ANN in general thermal problems are its fault tolerance and adaptability to changes in parameters. Yilmaz and Atik [4] concluded that ANN can be used in the performance estimation of heat exchangers with suitable network architecture and training sets. Datta et al. [5] provided predictions of AACs using the Levenberg-Marquardt algorithm of ANN and concluded that a forecast of the AACs is possible by using ANN. After evaluating fan coil power demand predicting ANN, Yaser et al. [6] stated that deep learning architectures may be further researched in the future. ANN and adaptive neuro-fuzzy were compared for various refrigerants by Arzu [7] and discovered that the ANN model is marginally superior for R134a refrigerant. After reviewing more than 90 studies, Mohanraj et al. [8] came to the conclusion that ANN may be employed effectively and accurately in the fields of heat transfer and air conditioning. A mobile air conditioning system was simulated using ANN by Atik [9], who detailed the impact of charge level and compressor rotation speed. An ANN was used by Belman et al. [10] to undertake a statistical study of the energy performance for a vapor compression system using R1234yf as the working fluid. For approximating air conditioning systems, Adelekan et al. [11] suggested feedforward neural network is an excellent predictive model; however, advancements in its performance are dependent on the precise specification of training, testing, and validation algorithms. According to Aprea [12] et al., ANN may be used to identify internal operating conditions and improve system performance. According to Gill et al. [13], artificial intelligence approaches may be used to determine system performance more precisely than conventional statistical methods. Increased use of hidden layers, according to Wang et al. [14], produces findings that are more precise. Kharwar and Verma [15] studied surface roughness (Ra) during the milling of Multiwall Carbon Nanotube reinforced polymer nanocomposites using ANN. The paper concludes that Vali-

ation through experimental and predicted values confirms the efficacy of the ANN model in optimizing machining processes for enhanced surface quality. Kharwar and Verma [16] by employing a hybrid approach combining Grey Relational Analysis (GRA) within an ANN framework based on the Taguchi method, research aims to achieve multi-criteria optimization in turning operations. The ANN, trained using the Levenberg-Marquardt Back Propagation algorithm, successfully predicted the optimal process parameters.

Thomas et al. [17] reports that two hidden layers of a neural network provide predictions that are more accurate than those produced by a single layer.

According to Gill and Singh [18], the application of AI technologies like adaptive neuro-fuzzy inference systems and ANN has expanded recently. When results from the mathematical model and artificial intelligence technique were examined, it was observed that the latter provided results with a higher degree of accuracy and quicker forecast.

Accurate air conditioning performance forecasting is crucial for advanced control and problem diagnostics. A long-memory recurrent network-based model for system performance prediction was proposed by Zhijie and Fu [19]. Researchers concluded that the suggested model can provide the desired result with reasonable accuracy. Using the DNN model, Kim et al. [20] were able to regulate the airflow of an air conditioner to increase its performance and energy efficiency. Lorenc et al. [21] used ANN model in the allocation of product. The paper demonstrated how employing multi-criterion clustering could boost order-picking productivity by using ANN. Vimal et al. [22] proposed an ANN model with drill diameter, spindle speed, and feed rate as input parameters while thrust force and torque as output parameters. Results obtained show ANN has very good agreement with experimental results.

In order to capture the link between the interior air temperature and the occupants' thermal comfort, Jin et al. [23] suggested a DNN model and discovered that its mean average error is roughly 0.1°C. Due to the complexity of the central air conditioning energy efficiency forecasting problem, Song et al. [24] suggested using DNN. They observed a strong connection between expected and actual outcomes when using an enhanced LSTM model to forecast the system's performance. Zhou et al. [25] contrasted the Long Short-Term Memory (LSTM) model with the Moving Average model (MAPE) and the backpropagation (BP) neural network model and discovered that, when compared to MAPE and BP, LSTM is more reliable at predicting outcomes. Salman et al. [26] used ANN in predicting the wind speed. The paper concludes that LSTM may be used for short-term prediction of wind speed with training input parameters. Ramkumar et al. [27] introduce ANN as a promising alternative to analytical models for accurately predicting the bond strength of composite joints. ANN models are trained with segregated acoustic emission data based on failure mechanisms and load percentages. The paper concluded that ANN is more accurate in predicting the failure load.

Mohandes et al. [28] used recurrent neural networks in speed prediction. And proposed model is effective in

wind speed predictions at different heights. Rehman et al. [29] investigate the challenges of predicting wind speed for wind power integration into the grid. By considering meteorological parameters like temperature and pressure, two nonlinear autoregressive neural network models are proposed for long-term wind speed prediction. The paper proposes a neural network model for predicting wind speed.

Recurrent neural networks (RNN) were used to construct the failure detection and isolation (FDI) methodology developed by Hadi et al. [30] for HVAC systems. There are many benefits, such as the fact that FDI can isolate defects described in study work without the need for mechanistic models, plant fault histories, or a set of expert criteria. Koçak and Şiray [31] proposed that, modeling complicated real-world issues like function approximation, classification, pattern recognition, and forecasting, ANNs are a commonly used computational modeling technique. Du et al. [32] employed particle swarm optimization (PSO) to find the appropriate number of hidden layer nodes and improve prediction model accuracy in DNN.

The DNN is the primary architectural framework used in deep learning algorithms. Deep learning algorithms utilize deep neural networks to automatically learn hierarchical representations of data for tasks. This architecture enables us to learn complex relationships. DNNs are a particular type of neural network; deep learning, on the other hand, is a more general field that has different methods for learning data representations. DNNs belong to the deep learning category.

According to the literature analysis indicated above, advancement in computational capabilities leads to numerous novel techniques to analyze and forecast the different parameters of the AACS. Artificial Deep Neural Network has not been used for AACS with R134a refrigerant. The objective of this paper is to present the use of DNN in predicting the parameters contributing to the performance of the air conditioning system. The experimental setup is prepared to analyze parameters. The DNN model is used to estimate the performance parameters of a vehicle's air conditioning, which include compressor work, Coefficient of performance (COP), and heat loss. Their projected values were compared to the actual experimental results.

3. ARTIFICIAL DEEP NEURAL NETWORK

The ANN is a modeling technique that has been encouraged by the biological nervous system of the brain. Unlike other machine learning models, ANN automatically discovers the intricate mathematical relationship between independent and dependent variables. Similar to the human brain, a neuron is the core processing element of the ANN. Every neuron gets inputs and multiplies them with corresponding weights to determine the significance of each input. The higher the weight, the more significant the input for the prediction. The weighted input is added together to produce the output. This is shown by the following formula:

$$z = \left(\sum_{c=1}^n w_c * i_c \right) + b \quad (1)$$

where w_c and i_c are the weights and inputs to the neuron. The term 'n' indicates the total number of inputs to the neuron. The term 'b' is called bias. It is used to express the displacement of a line along the x-axis. This formula identifies the linear relationship between independent and dependent variables. To learn the complex non-linear relationship, it undergoes the function called the activation function. Sigmoid, Tanh, ReLU, Leaky ReLU, and softmax are the various non-linear activation functions. In conclusion, the output of the neuron is determined using the following formula:

$$o = f \left(\left(\sum_{c=1}^n w_c * i_c \right) + b \right) \quad (2)$$

where 'o' is the output of neuron while 'f' is the activation function. In general, the structure of an ANN model is made up of three core layers: an input, a hidden layer, and an output layer. Each neuron belongs to one of these three layers. Hasan Avci, et al. [33] mentioned that the ANN model's performance is influenced by the network's properties, like the count of hidden layers and the neurons. Fig. 1 depicts the arrangement of neurons in the layers for AACS. Inputs are involved in the first layer. The first layer consists of three neurons conforming to Compressor Speed, Air temperature at the Inlet of the Evaporator, and Refrigerant Flow Rate refereeing N , $T_{a,i, \text{evap}}$, and \dot{m}_r , respectively. There is no connection between the neurons from the same layer. But, every neuron from the input is connected to every other neuron present in the next layer. The next layer is hidden. It is made up of 16 neurons. These neurons are helpful for learning complicated and essential features from input on their own. These are referred to as hidden neurons since they cannot be interpreted from the outside. Again neurons from the hidden layer are connected to every other neuron from the next hidden layer. In many cases, numerous hidden layers are added to learn intricate non-linear relationship between dependent and independent variables.

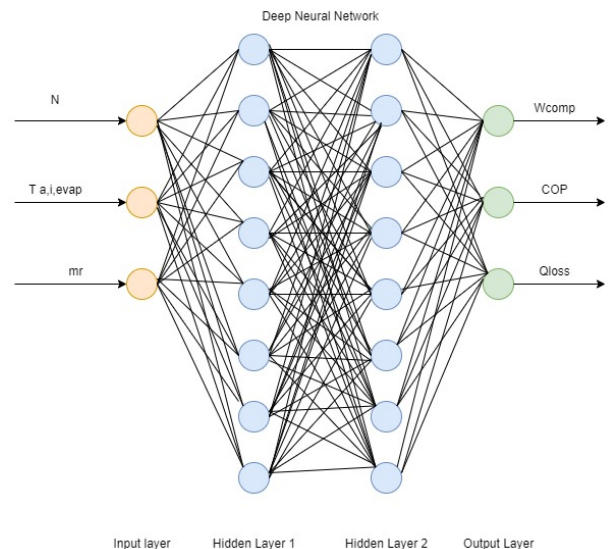

Figure 1. Arrangement of Neurons in Deep Neural Network

Initial hidden layers learn simple features from the input while later hidden layers learn the complex fea-

tures by combining simple features learned from previous layers. If the number of hidden layers is two or greater than two, then such neural networks are called DNN. It has more learning capability than shallow neural networks having only one hidden layer. At the end, neurons of the final hidden layers are connected to the output layer, which is at last of ANN architecture. The output layer consists of three neurons corresponding to Compressor Work, Coefficient of Performance (COP), and Heat Loss referring to W_{comp} , COP and Q_{loss} respectively.

Learning mechanism in neural network refers to the process of identifying correct weights and bias so that the difference between predicted and actual output is as small as possible. The loss function is a measure of the difference between predicted and actual outputs. MSE and MAE are the famous loss functions utilized to measure the difference between real-valued predicted and actual output. The optimization algorithm plays an important role in guiding neural networks to update the weights. It takes partial derivation of the loss function to decide the new weights and bias. It is calculated by the following formula.

$$W_{new} = W_{old} - \alpha * \frac{\partial L}{\partial W} \quad (3)$$

where W_{new} and W_{old} are new and old weights before and after weight modification, while α refers to the learning rate. It decides how much magnitude we have to consider from the partial derivation of the loss function with respect to weight represented by $\frac{\partial L}{\partial W}$. The proposed model is developed with Tensorflow 2.0 in Jupyter Notebook with Anaconda Package Manager.

4. NEURAL NETWORK VALIDATION

To assess the DNN model, statistical investigation is employed, specifically utilizing the correlation coefficient (R) to understand the relationship and dependency between different variables. RMSE and MAE are used to compare the predicted outputs of the DNN model to the actual experimental results.

The value of R [where, $-1 \leq R \leq 1$] is employed to quantify the degree of correlation between the anticipated outputs and the experimental output. The R-value tending to 1 indicates a strong positive relation between the x and y data sets. Conversely, a value nearer to -1 suggests a strong negative linear relation between data. It indicates a weak or no relationship between the data sets for value close to zero, irrespective of sign.

The average magnitude of the error is given by RMSE. The square root of the summation of the square of the difference between predicted and actual observation divided by a number of observations shows RMSE. As follows:

$$RMSE = \sqrt{\frac{1}{n} \left(\sum_{j=1}^n (y_j - y_j^p) \right)^2} \quad (4)$$

where y_j are actual values while y_j^p are predicted values and n represents the total number of observations.

Average magnitude errors in prediction are given by MAE irrespective of their direction. It is calculated using the following formula.

$$MAE = \frac{1}{n} \sum_{i=1}^n (y_j - y_i^p)^2 \quad (5)$$

where y_i shows actual values and y_i^p shows predicted values, and n represents the total number of observations.

5. DESCRIPTION OF EXPERIMENTAL SETUP

The AACS experimental rig developed for the experimentation purpose is shown in the schematic diagram Fig. 2. It is divided into two sections: a vapor compression refrigeration unit which consists of a swash plate compressor, microchannel evaporator along with closed air duct, microchannel condenser, expansion valve, insulated pipes which connect the component to pass refrigerant as shown in this diagram. The ducts were planned and built in accordance with industry standards. The AACS was built utilizing authentic components used for AACS which uses R-134a refrigerant. The evaporator section's air duct has a 500 mm length, with a closed loop rectangular cross-section. Thick wool material is utilized as insulating material for the duct walls between the evaporator coil's ends. A centrifugal fan with a variable speed arrangement was used to drive air through the duct. The heating load to the evaporator coil is adjusted by using a 2 kW electrical power heater. Air temperature and humidity is maintained by the heating and humidification sections at the evaporator coil's inputs.

Two kW electrical powered heater employed at the condenser coil's entrance to maintain required ambient temperature. Two pt100 resistance temperature detector (RTD) sensors were used to gauge the air temperature upstream and downstream of the evaporator coil. Another RTD sensor with the same specification is used to measure the upstream temperature of the condenser coil. Two air velocity transducers were used to measure the speed of air flowing through the evaporator and condenser coils. The compressor speed was controlled by a frequency inverter. The temperature of the refrigerant was measured at various places in the vapor-compression refrigeration circuit using Type-K thermocouples inserted into copper tubing. The pressure at the suction and discharge parts of the compressor has been checked with a Bourdon tube pressure gauge. The suction pressure corresponds to evaporating pressure while discharge pressures is corresponding to condensing pressures since we presupposed no pressure loss in the pipes. A flow meter was fitted at the condenser's output to monitor the flow of refrigerant. To ensure that the refrigerant is always sub-cooled, a transparent glass tube was mounted. The AACS was run in the experiments until it reached a steady state. During trials, 4 operating parameters were adjusted, each within its own range. Velocity of the condenser air maintained at around 1.6 m/s throughout the experiment.

The measuring tools used in the experiments for the various properties are displayed in Table 1. The corresponding equipment's range and uncertainty are also

shown in the table. The equipment's uncertainty is within allowable bounds.

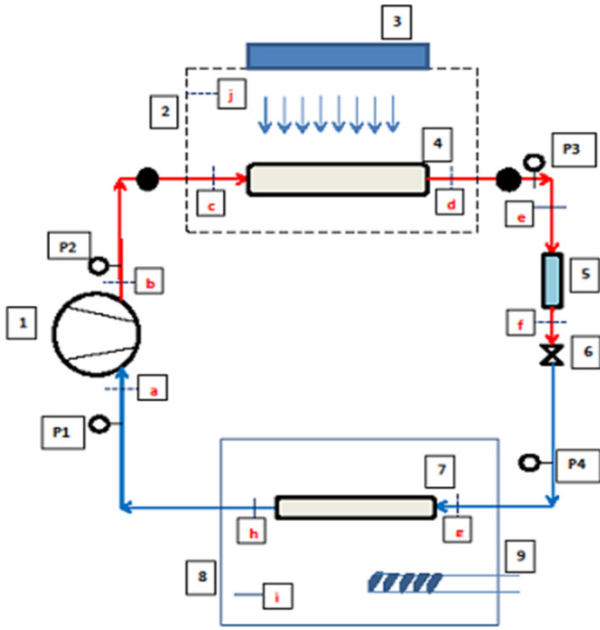

Components used	Indicators used	
1.Variable Speed Compressor	P1:Compressor Inlet Pressure	f: Rotameter Outlet Temp.
2.Insulated Space	P2: Compressor Outlet Pressure	g: Evaporator Inlet Temp.
3.Outside AC System	P3:Condenser Outlet Pressure	h:Evaporator Outlet Temp.
4.Air Cooled Condenser	P4: Evaporator Outlet Pressure	i: Evaporator Space Temp.
5.Rotameter	a: Compressor Inlet Temp.	j: Condenser Space Temp.
6.Expansion Device	b: Compressor Outlet Temp.	
7.Evaporator	d: Condenser Outlet Temp.	
8. Insulating Space	e: Rotameter Inlet Temp.	
9. Room Heater		

Figure 2. Schematic Diagram Experimental Arrangement

Table 1. Measurement Instruments, Range, and Uncertainty

Measured variable	Instrument	Range	Uncertainty
Temperature	K type	-270to 1260°C	±2°C
Pressure	Burdon Gauge	0-20 bar	±1%
Air Velocity	Flow meter	0-25 m/s	--
Mass flow rate	Rotameter	0-100 LPH	±1.5%
Compressor speed	Digital Tachometer	0-20,000RPM	±2%
Current	Ammeter	0-20A	±1%

6. PERFORMANCE ANALYSIS OF ACCS

The components of ACCS as mentioned in the setup description have four components an Evaporator, condenser, compressor, and expansion valve. At all times these components are running in steady state mode. In contrast to heat and work exchanges, the kinetic and potential energy changes of the refrigerant R134a are disregarded. For each component considering the steady state equations steady flow equations are used and heat transfer from each component are evaluated as per following equations. For the condenser, it is important to consider phases like heat transfer in the superheated region ($Q_{cond,sh}$), two-phase flow region ($Q_{cond,tp}$), and subcooled region ($Q_{cond,sc}$) while in the evaporator heat transfer in superheated ($Q_{evp,sh}$) flow and two-phase ($Q_{evp, tp}$) flow are considered.

$$Q_{cond} = N_{tubes} (\sum Q_{cond,sh} + \sum Q_{cond,tp} + \sum Q_{cond,sc}) \quad (6)$$

$$Q_{evap} = \sum Q_{evp,tp} + \sum Q_{evp,sh} \quad (7)$$

$$W_{comp} = m_r \cdot (h_{out} - h_{in}) + Q_{loss} \quad (8)$$

The m_r shows the mass flow rate of refrigerant in a vapor compression refrigeration system, and considering the enthalpies (h_{out} , h_{in}) and efficiency we can evaluate the work done by the compressor as given in the equation. The performance analysis of the ACCS can be determined with the help of the COP of the system. In this research work COP of the system depending upon the above equation considered a performance parameter. For various speeds of the compressor, we have different mass flow rates and heat loss for the compressor. This variation also leads to differences in heat transfer in the condenser and evaporator. So we can vary the speed and these leads to variation of COP of the system. This variation is considered an operating parameter in further study.

7. DNN MODEL OF THE ACCS

DNN model is used in the experimentation of ACCS as a real value prediction model. Data acquisition, designing DNN, construction of DNN and training along with hyperparameter tuning for getting better results Figure 3 shows a schematic structure of the proposed DNN model with ACCS. Model uses three input variables as x and uses ACCS-generated y as an actual output. Deep learning model trains of these x and y pairs by learning hidden representations between them. The output y^p is used with an error function to calculate the difference e with the actual output y .

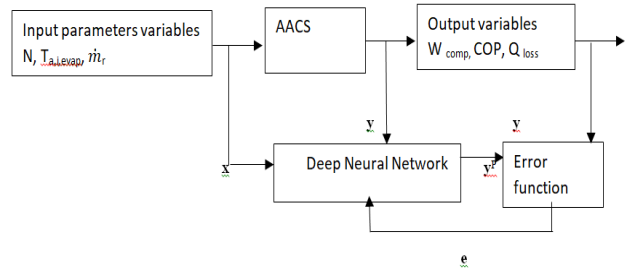

Figure 3. Schematic Structure of Proposed DNN Model with ACCS

Typically, a DNN contains one input, two or more hidden, and one output layer. Shallow neural networks consist of one input layer, one hidden layer, and one output layer. Such neural networks have limited capacity to learn the complex relationship between input and output variables. The proposed deep learning model exhibits more power to learn complex relationship between input and output variable. Its first hidden layer learns basic features of input while the second hidden layer learns complex features to provide better prediction results.

8. PARAMETRIC STUDY ON THE DNN MODEL

In every neural network, a few values need to be set ahead of actual learning or training. For example, count

of neurons in layers and selection of activation function. These values are called hyperparameters. We can set the values of our choice for testing. But this set of values affects the accuracy. So, it is important to identify the correct set of hyper-parameters to improve the accuracy of the network. This section describes the effect of hyper-parameters over accuracy.

For the experimentation, 90% data is used for training while 10% data is used for validation. From the total 70 samples, 63 samples are used for training while the remaining 7 samples are used for validation. Every training sample holds the Compressor Speed, Air temperature at the Inlet of the Evaporator, and Refrigerant Flow Rate refereeing as input while Compressor Work, Coefficient of Performance (COP), and Heat Loss as actual output. The model is trained to learn the relationship between inputs and actual outputs. In validation, unseen 10% data is used to understand how well our model learned the relationship between inputs and output. Predicted values of the validation dataset are checked with actual output values of the validation dataset to check the learning.

The model generates a continuous range of values instead of discrete categories corresponding to the compressor work, COP, and heat loss. The efficiency of AACS is measured by these outcomes, hence selected as output parameters. To evaluate the discrepancy between the predicted and actual values, the system employs RMSE and MAE. RMSE measures the square root of the average of the squared differences between the predicted and actual values. MAE measures the average magnitude of the errors between predicted values and actual values without considering their direction. This means it looks at the absolute differences between these values, which makes it straightforward to interpret.

8.1 DNN model with different numbers of neurons

While developing DNN, the number of neurons in each layer is a critical aspect in defining the network's performance and capabilities. The number of neurons influences the network's capacity to learn complex patterns and make accurate predictions. It is useful for handling complex relationship between input and output along with overfitting and underfitting. In practice, the optimal number of neurons is determined through experimentation and iterative tuning. Table 2 shows the error from the system with the change in the count of neurons.

Table 2. Error from the System with Change in Number of Neurons

# Neurons in Hidden Layer 1	# Neurons in Hidden Layer 2		
	16	32	64
16	5×10^{-3}	4×10^{-3}	3×10^{-3}
32	4×10^{-3}	3×10^{-3}	2×10^{-3}
64	3×10^{-3}	3×10^{-3}	3×10^{-3}

From Table 2 it is observed that results are more accurate corresponding to 32 neurons in the first hidden layer while 64 neurons are the second hidden layer. Table 3 indicates the standard deviation for the trained model. It indicates the model stability with the unseen

data. Less standard deviation indicates the model is more stable to the unseen data. The same 32 and 64-neuron combination shows better stability with the trained model.

Table 3. Standard Deviation for the Trained Model

# Neurons in Hidden Layer 1	# Neurons in Hidden Layer 2		
	16	32	64
16	2×10^{-3}	3×10^{-3}	3×10^{-3}
32	1×10^{-3}	3×10^{-3}	1×10^{-3}
64	2×10^{-3}	2×10^{-3}	2×10^{-3}

9. RESULT ANALYSIS AND DISCUSSION

From the parametric study of neural network, it is observed that the DNN with two hidden layers with 32 and 64 neurons respectively provides better result. The same model architecture is used to plot the error curve for RMS and MAE with 200 epochs. The small number of epochs results in underfitting while the huge number results in overfitting. Therefore epochs are set to 200. Fig. 4 represents these errors vs epochs. From the figure it is observed that RMS and MAE decrease drastically after a few epochs and generate more stable relationship.

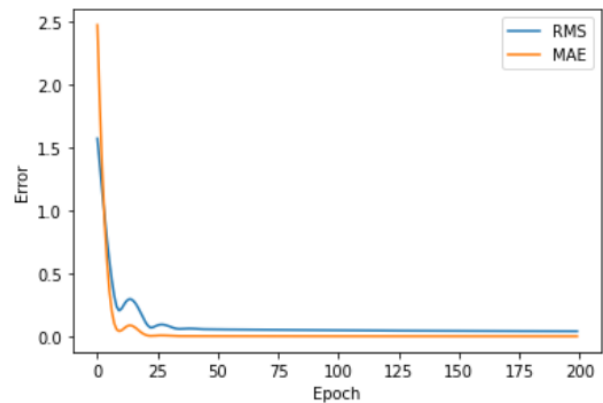
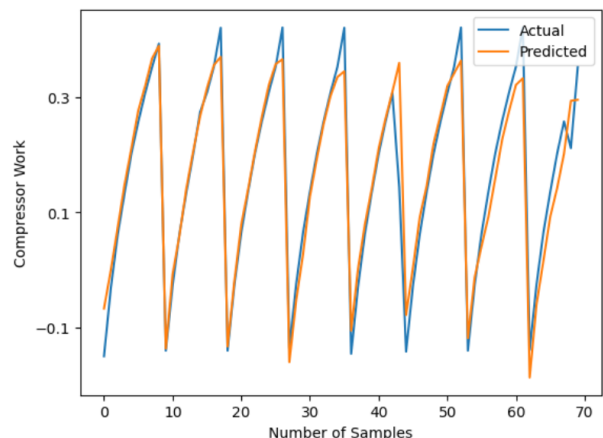
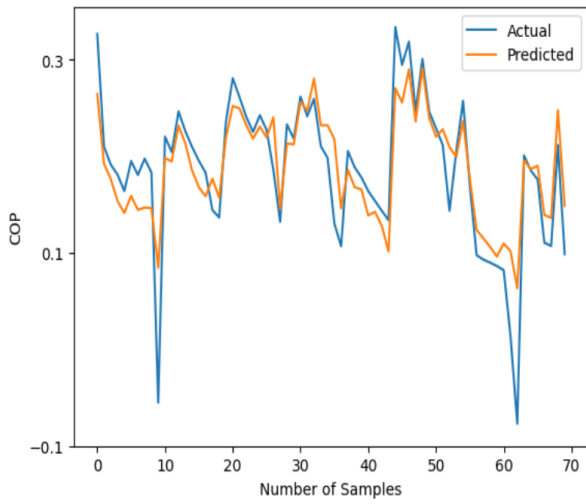

Figure 4. Variation of RMSE and MAE with Respect to Epochs

Figures 5 (a), 5 (b) and 5 (c) represent the predicted and actual values for various samples for compressed work, COP, and heat loss respectively. Every graph shows that predicted and actual values are close to each other. These graphs indicate that predicted and actual value lines follow the same direction and structure.



(a)



(b)

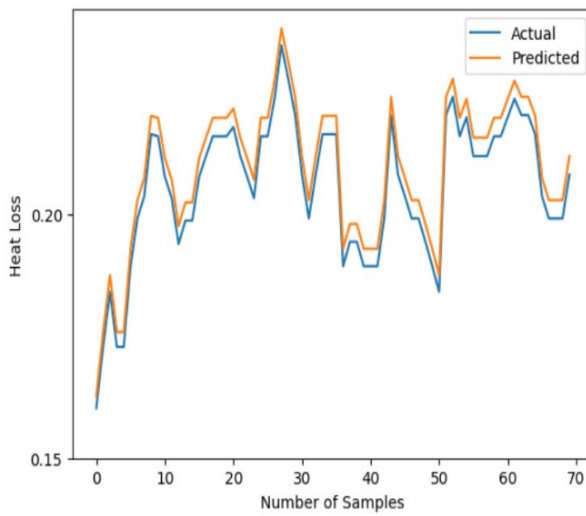

(c)

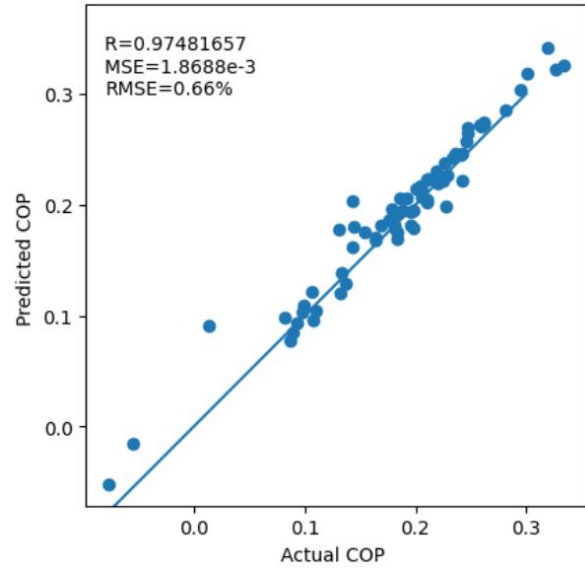

(a)

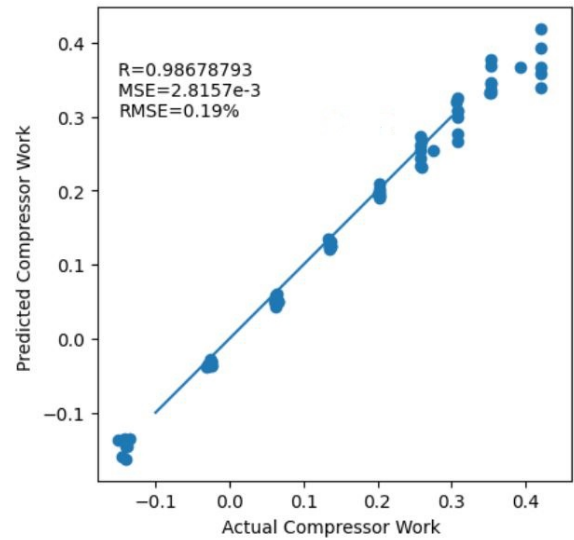

(b)

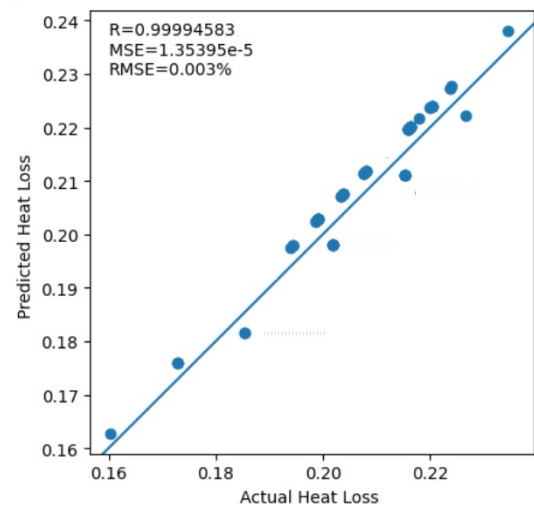

(c)

Figure 5. Actual and Predicted (a) Compressor Work (b) COP (c) Heat Loss with Respect to Number of Samples

Several statistical measures, such as R, MSE, and RMSE have been chosen to evaluate the DNN model's performance. Figure 6 (a) shows a plot of predicted COP versus experimental COP. The DNN produces $R = 0.9748$, MSE of 1.8688×10^{-3} and RMSE of 0.66% in this instance. The findings obtained by DNN prediction exhibit very good accuracy with the obtained experimental results, as indicated by the R, MSE, and RMSE.

Figure 6 (b) shows predicted compressor work compared with actual compressor work. The plot displays the correlation coefficient, which indicates a positive connection between the actual and expected values at 0.9867. MSE 0.19% and RMSE value is 2.8157×10^{-3} . It concludes that when compared to experimental findings, the DNN model displays precise results.

Figure 6 (c) indicates variation of DNN predicted result with respect to actual experimental results. The results obtained indicate a 0.9999 correlation coefficient, 0.003% RMSE, and 1.3539×10^{-3} MSE. Which shows good accuracy with DNN predicted results and experimental results.

Figure 6. (a) Actual COP versus Predicted COP (b) Actual Compressor Work versus Predicted Compressor work (c) Actual Heat Loss versus Predicted Heat Loss

10. CONCLUSION

The DNN model is used to predict the performance of AACS. Out of the three layers of DNN, the first one is the input layer which consists of three neurons corresponding to inputs. The second layer is the hidden layer. Neurons from the hidden layer contribute to the learning ability of the complex non-linear relationship between input and output. The output layer with 3 neurons is the third layer. The performance of DNN is accessed by using R, RMSE, and MSE. Based on the results obtained specified DNN model can be effectively used in predicting the performance of the AACS. The correlation coefficient between predicted and actual experimented values for COP, compressor work, and actual heat loss are 0.9748, 0.9867, and 0.9999 respectively. All of the aforementioned parameters' R values were discovered to be extremely near to one, showing that the DNN model can accurately predict the performance characteristics of the AACS. The values of RMSE and MSE are also found to be quite low, which supports the assertion that the findings produced have strong agreement with the outcomes of the experiments and may be used successfully for performance prediction.

The DNN model developed, significantly enhances the understanding of complex relationships between dependent and independent variables, leading to optimized designs. These models accelerate the design process and minimize the need for physical prototypes. DNN model can be used for prediction as well as validation of the results accurately. Automotive environments are dynamic, with factors such as weather conditions, driving patterns, and vehicle load constantly changing. DNNs can adapt to these evolving conditions by continuously learning from new data. This adaptability allows DNN-based prediction models to maintain accuracy over time, even as operating conditions fluctuate.

Deep learning's adaptability allows for tailored solutions and continuous learning from new data. Integration with IoT and big data facilitates real-time monitoring and analysis, turning vast datasets into actionable insights, ultimately leading to more efficient, cost-effective, and innovative engineering outcomes.

Declarations

Conflict of interest - The corresponding author states that there is no conflict of interest on behalf of all authors.

REFERENCES

- [1] A. Kargilis, Design and Development of Automotive Air Conditioning Systems, ALKAR Engineering Company, 2003.
- [2] Bamisaye, Olufemi Sylvester, et al. "Investigation of the Effects of Air-Conditioning System on the Temperature and Speed of Automobile Engine Using Paired T-Test and Regression Analysis." *OALib*, vol. 06, no. 01, 2019, pp. 1–14.
- [3] Yang, Kwang-Tzu. "Artificial Neural Networks (ANNs): A New Paradigm for Thermal Science and Engineering." *Journal of Heat Transfer*, vol. 130, no. 9, 9 July 2008.
- [4] Yilmaz, Sezayi, and Kemal Atik. "Modeling of a Mechanical Cooling System with Variable Cooling Capacity by Using Artificial Neural Network." *Applied Thermal Engineering*, vol. 27, no. 13, Sept. 2007, pp. 2308–2313.
- [5] Datta, Santanu Prasad, et al. "An Optimized ANN for the Performance Prediction of an Automotive Air Conditioning System." *Science and Technology for the Built Environment*, vol. 25, no. 3, 4 Feb. 2019, pp. 282–296.
- [6] Alamin, Yaser I., et al. "An Artificial Neural Network (ANN) Model to Predict the Electric Load Profile for an HVAC System" *IFAC-PapersOnLine*, vol. 51, no. 10, 2018, pp. 26–31.
- [7] Şahin, Arzu Şencan. "Performance Analysis of Single-Stage Refrigeration System with Internal Heat Exchanger Using Neural Network and Neuro-Fuzzy." *Renewable Energy*, vol. 36, no. 10, Oct. 2011, pp. 2747–2752.
- [8] Mohanraj, M., et al. "Applications of Artificial Neural Networks for Refrigeration, Air-Conditioning and Heat Pump Systems—a Review." *Renewable and Sustainable Energy Reviews*, vol. 16, no. 2, Feb. 2012, pp. 1340–1358.
- [9] Atik, Kemal, et al. "Performance Parameters Estimation of MAC by Using Artificial Neural Network." *Expert Systems with Applications*, vol. 37, no. 7, 1 July 2010, pp. 5436–5442.
- [10] Belman-Flores, J.M., Sergio Ledesma. "Statistical Analysis of the Energy Performance of a Refrigeration System Working with R1234yf Using Artificial Neural Networks." *Applied Thermal Engineering*, vol. 82, May 2015, pp. 8–17.
- [11] Adelekan, D.S., et al. "Artificial Intelligence Models for Refrigeration, Air Conditioning and Heat Pump Systems." *Energy Reports*, vol. 8, Nov. 2022, pp. 8451–8466.
- [12] Aprea, Ciro, et al. "An Application of the Artificial Neural Network to Optimise the Energy Performances of a Magnetic Refrigerator." *International Journal of Refrigeration*, vol. 82, Oct. 2017, pp. 238–251.
- [13] Gill, Jatinder, et al. "Adaptive Neuro-Fuzzy Inference System (ANFIS) Approach for the Irreversibility Analysis of a Domestic Refrigerator System Using LPG/TiO₂ Nanolubricant." *Energy Reports*, vol. 6, Nov. 2020, pp. 1405–1417.
- [14] Wang, Zhichao, et al. "Energy Performance Prediction of Vapor-Injection Air Source Heat Pumps in Residential Buildings Using a Neural Network Model." *Energy and Buildings*, vol. 228, Dec. 2020, p. 110499.
- [15] Prakhar Kharwar, Rajesh Verma. "Artificial Neural Network-Based Modeling of Surface Roughness in Machining of Multiwall Carbon Nanotube Reinforced Polymer (Epoxy) Nanocomposites." *FME Transactions*, vol. 48, no. 3, 1 Jan. 2020, pp. 693–700.
- [16] Prakhar Kumar Kharwar, Rajesh Kumar Verma. "Grey Embedded in Artificial Neural Network (ANN) Based on Hybrid Optimization Approach in Machining of GFRP Epoxy Composites." *FME Transactions*, vol. 47, no. 3, 1 Jan. 2019, pp. 641–648.

- [17] Thomas, Alan J., et al. "Two Hidden Layers Are Usually Better than One." *Engineering Applications of Neural Networks*, 2017, pp. 279–290.
- [18] Gill, Jatinder, and Jagdev Singh. "An Applicability of ANFIS Approach for Depicting Energetic Performance of VCRS Using Mixture of R134a and LPG as Refrigerant." *International Journal of Refrigeration*, vol. 85, Jan. 2018, pp. 353–375.
- [19] Zhijie, Chen, and Xiao Fu. "Dynamic Performance Prediction of Vehicle Variable Speed Air Conditioner Based on LSTM Recurrent Neural Network". *Applied Energy Symposium 2020: Low carbon cities and urban energy systems*. October 10-17, 2020.
- [20] Kim, Sunghak, et al. "Deep Neural Network Based Ambient Airflow Control through Spatial Learning." *Electronics*, vol. 9, no. 4, 31 Mar. 2020, p. 591.
- [21] Lorenc, Augustyn, et al. "Solving Product Allocation Problem (PAP) by Using ANN and Clustering." *FME Transactions*, vol. 49, no. 1, 2021, pp. 206–213.
- [22] Vimal, Sam, et al. "Python Inspired Artificial Neural Networks Modeling in Drilling of Glass-Hemp-Flax Fiber Composites." *FME Transactions*, vol. 49, no. 2, 2021, pp. 422–429.
- [23] Jin, Jing, et al. "Prediction of Indoor Air Temperature Based on Deep Learning." *Sensors and Materials*, vol. 31, no. 6, 28 June 2019, p. 2029.
- [24] H. Song, Y. Chen, J. Li, T. Wang, H. Shen and C. He, "Energy Efficiency Forecasting for Central Air-conditioning Refrigeration Systems Based on Deep Neural Network," *2022 IEEE International Conference on Networking, Sensing and Control (ICNSC)*, Shanghai, China, 2022, pp. 1-5.
- [25] Zhou, Chonggang, et al. "Using Long Short-Term Memory Networks to Predict Energy Consumption of Air-Conditioning Systems." *Sustainable Cities and Society*, vol. 55, Apr. 2020, p. 102000.
- [26] Salman, Umar, et al. "Short Term Prediction of Wind Speed Based on Long-Short Term Memory Networks." *FME Transactions*, vol. 49, no. 3, 2021, pp. 643–652.
- [27] Ramkumar Sathiyamurthy, et al. "Acoustic Emission Based Deep Learning Technique to Predict Adhesive Bond Strength of Laser Processed CFRP Composites." *FME Transactions*, vol. 48, no. 3, 1 Jan. 2020, pp. 611–619.
- [28] Mohandes, M., et al. "Accuracy of Wind Speed Predictability with Heights Using Recurrent Neural Networks." *FME Transactions*, vol. 49, no. 4, 2021, pp. 908–918.
- [29] Rehman, Shafiqur, et al. "Wind Speed Prediction Based on Longshort Term Memory Using Nonlinear Autoregressive Neural Networks." *FME Transactions*, vol. 50, no. 2, 2022, pp. 260–270.
- [30] Shahnazari, Hadi, et al. "Modeling and Fault Diagnosis Design for HVAC Systems Using Recurrent Neural Networks." *Computers & Chemical Engineering*, vol. 126, July 2019, pp. 189–203.
- [31] Koçak, Yılmaz, and Gülesen Üstündağ Şiray. "New Activation Functions for Single Layer Feedforward Neural Network." *Expert Systems with Applications*, vol. 164, Feb. 2021, p. 113977.
- [32] L. Du, X. Li, K. Wang and Y. Li, "Prediction of HVAC Energy Consumption Using PSO Optimized Deep Neural Network," *2023 IEEE 12th Data Driven Control and Learning Systems Conference (DDCLS)*, Xiangtan, China, 2023, pp. 52-57.
- [33] Hasan Avci, et al. "Optimisation of the Design Parameters of a Domestic Refrigerator Using CFD and Artificial Neural Networks." *International Journal of Refrigeration-Revue Internationale Du Froid*, vol. 67, 1 July 2016, pp. 227–238.

NOMENCLATURE

w_c	Weights
i_c	Inputs to Neuron
b	Bias
o	Output of the Neuron
N	Compressor Speed
$T_{a.i.evap}$	Air inlet Temperature at evaporator inlet
\dot{m}_r	The mass flow rate of refrigerant
W_{comp}	Compressor work
Q_{loss}	Heat Loss
W_{new}	New weights
W_{old}	Old weights
L	Loss function
y_i	Actual Value
y^p_i	Predicted Value
n	Total Number of Observations
Q	Heat transfer
h	Enthalpy
e	error

Greek symbols

α	Learning rate
----------	---------------

Superscripts

cond	Condenser
evp	Evaporator
sh	Super-heated
tp	Two-phase
sc	Subcooled
out	Outlet
in	Inlet

ABBREVIATIONS

AACS	Automotive Air Conditioning System
ANN	Artificial Neural Network
DNN	Deep Neural Networks
AI	Artificial Intelligence
LSTM	Long Short-Term Memory
MAPE	Moving Average model
BP	Back Propagation
RNN	Recurrent Neural Networks
FDI	Failure Detection and Isolation
HVAC	Heating, Ventilation, Air Conditioning
PSO	Particle Swarm Optimization

COP	Coefficient of Performance
ReLU	Rectified Linear Unit
MSE	Mean Square Error
RMSE	Root Mean Square Error
MAE	Mean Absolute Error
RTD	Resistance Temperature Detector
R	correlation coefficient

ПРЕДВИЂАЊЕ ПЕРФОРМАНСИ СИСТЕМА ЗА КЛИМАТИЗАЦИЈУ АУТОМОБИЛА КРОЗ ДУБОКО УЧЕЊЕ

П.М. Гавали, С.Д. Јадав

Аутомобилски систем климатизације (ААЦС) укључује фазну промену расхладног средства, како би се обезбедило удобно окружење у кабини возила. Про-

мена фазе је регулисана многим сложеним једначинама. Због тога је потребна техника која може да потврди резултате и предвиди перформансе система да би се избегла заморна израчунавања. Дубоке неуронске мреже (ДНН) су боље у учењу сложених нелинеарних односа између метрика учинка. Експериментални подаци се користе за обуку наведеног ДНН модела. Брзина компресора, температура ваздуха на улазу у испаривач и брзина протока расхладног средства се користе као улаз, док су коефицијент перформанси, рад компресора и губитак топлоте коришћени као излазни параметри за обуку модела. Предвиђени резултати се пореде коришћењем статистичких мера као што су средња квадратна грешка, средња квадратна грешка као и коефицијент корелације. На основу добијених резултата, наведени ДНН модел се може ефикасно користити у предвиђању и валидацији перформанси ААЦС-а.